



POINT MOBILE CO., LTD.
B-9F, Kabul Great Valley, 32, Digital-Ro 9Gil
Geumcheon-gu, Seoul, Korea 153-709
www.pointmobile.co.kr

Model :	Originator :	Version :	Dept.	Date :
PM260	Chloe Kim	1.0	PC/PE/ID/PM/QA	May. 15 th , 2013

PM260 User Manual

CONTENTS

1. INTRODUCTION	5
<i>Trademarks</i>	5
<i>About the PM260 Handy Terminal</i>	5
<i>Accessories</i>	5
2. SAFETY REGULATIONS	6
2.1. <i>General Safety Rules</i>	7
2.2. <i>Power Supply</i>	7
2.3. <i>Laser Safety</i>	7
2.4. <i>LED Safety</i>	9
2.5. <i>FCC RF Exposure</i>	9
2.6. <i>CB Scheme</i>	9
2.7. <i>FCC Part 15 Regulation</i>	9
2.8. <i>Canadian Compliance</i>	9
2.9. <i>Radio Compliance</i>	10
2.10. <i>WEEE Compliance</i>	10
2.11. <i>China Compliance</i>	11
3. GETTING STARTED	11
3.1. <i>Install the Battery</i>	11
3.2. <i>Charge the Batteries</i>	12
3.3. <i>LED Indicators</i>	13
3.4. <i>Guidelines for Battery Pack Use and Disposal</i>	13
3.5. <i>Turn Your Device On</i>	14
3.6. <i>Desktop</i>	15
3.7. <i>Indicator Icons</i>	15
3.8. <i>Using the Stylus</i>	16
3.9. <i>Selecting Program</i>	16
3.10. <i>Pop-Up Menus</i>	16
3.11. <i>Using Windows Explorer</i>	17
4. GET TO KNOW YOUR DEVICE	17
4.1. <i>Feature of Your Device</i>	17
4.2. <i>PM260 Handy Terminal</i>	17
4.3. <i>Front Panel Layout</i>	18
4.4. <i>Display Backlight</i>	19
4.5. <i>Keypad Backlight</i>	19
4.6. <i>Using Screen Protectors</i>	20
4.7. <i>Installing Your Screen Protector</i>	20
4.8. <i>Back Panel Layout</i>	22
4.9. <i>Left Side Panel Layout</i>	24
4.10. <i>Installing Memory Cards</i>	24
4.11. <i>Right Side Panel Layout</i>	25
4.12. <i>Top Panel Layout</i>	25
4.13. <i>Bottom Panel Layout</i>	26
4.14. <i>Peripherals and Accessories</i>	27
4.15. <i>USB ActiveSync Cable</i>	27

4.16.	<i>Li-ion Battery Packs</i>	27
4.17.	<i>Battery Power</i>	27
4.18.	<i>Main Battery Pack</i>	28
4.19.	<i>Managing Main Battery Power</i>	28
4.20.	<i>Storage Guidelines</i>	29
4.21.	<i>Internal Backup Battery</i>	29
4.22.	<i>Resetting the Terminal</i>	30
4.23.	<i>Suspend Mode</i>	30
4.24.	<i>Memory Allocation</i>	31
4.25.	<i>Care and Cleaning of the Products</i>	31
4.26.	<i>PM260 Technical Specifications</i>	31
5.	USING THE KEYPAD	33
5.1.	<i>Numeric Keypad Layout</i>	33
5.2.	<i>Navigation Keys</i>	33
5.3.	<i>Basic Keys</i>	33
5.4.	<i>Alpha/Numeric Modes</i>	34
5.5.	<i>Alpha Indicators on the Numeric Keys</i>	34
5.6.	<i>BLUE Key Combinations</i>	34
5.7.	<i>RED Key Combinations</i>	35
5.8.	<i>Program Buttons</i>	36
6.	USING THE IMAGE ENGINE	36
6.1.	<i>Overview</i>	36
6.2.	<i>Available Image Engines</i>	37
6.3.	<i>Depth of Field</i>	37
6.4.	<i>Supported Bar Code Symbolologies</i>	38
6.5.	<i>Activating the Engine</i>	38
6.6.	<i>Using Demos</i>	39
6.7.	<i>Decoding</i>	39
6.8.	<i>To Decode a Bar Code</i>	39
6.9.	<i>Sample Bar Codes</i>	39
6.10.	<i>Omni-Directional Scanning Positions</i>	39
6.11.	<i>Capturing Images (IT5300SR Engine Only)</i>	40
7.	USING THE LASER ENGINE	40
7.1.	<i>Overview</i>	40
7.2.	<i>Available Laser Engines</i>	40
7.3.	<i>Depth of Field</i>	40
7.4.	<i>Supported Bar Code Symbolologies</i>	41
7.5.	<i>Activating the Engine</i>	41
7.6.	<i>Using Demos</i>	41
7.7.	<i>Decoding a Bar Code</i>	41
7.8.	<i>Sample Bar Code</i>	42
7.9.	<i>Scanning Positions</i>	42
8.	USING SCANWEDGE	42
8.1.	<i>Overview</i>	42
8.2.	<i>Enabling ScanWedge</i>	42

9.	USING CONTROL PANEL	43
9.1.	<i>System Properties</i>	43
9.2.	<i>General</i>	43
9.3.	<i>Memory</i>	44
9.4.	<i>Device name</i>	44
9.5.	<i>Copyrights.....</i>	44
9.6.	<i>Power properties</i>	45
9.7.	<i>Battery tab</i>	45
9.8.	<i>Power off tab</i>	45
9.9.	<i>CPU Power Setting Tab.....</i>	46
9.10.	<i>Alerts Tab</i>	46
9.11.	<i>Wakeup Source Tab</i>	46
9.12.	<i>Program Button properties</i>	47
9.13.	<i>Program Buttons Tab</i>	47
9.14.	<i>Key define Tab.....</i>	47
9.15.	<i>Backlight Properties</i>	48
9.16.	<i>Battery power Tab</i>	48
9.17.	<i>External power Tab.....</i>	48
9.18.	<i>Keyboard backlight Tab</i>	49
9.19.	<i>Scanner Settings.....</i>	49
9.20.	<i>Scanner Settings Applet.....</i>	49
10.	COMMUNICATION	51
10.1.	<i>Communication Options.....</i>	51
10.2.	<i>Installing Additional Software</i>	52
10.3.	<i>Connecting the USB ActiveSync Cable</i>	52
10.4.	<i>ActiveSync Communication</i>	53
10.5.	<i>Communication Type</i>	53
10.6.	<i>Hardware Requirements for Setup</i>	53
10.7.	<i>Software Requirements for Communication</i>	53
10.8.	<i>Setting Up the Host Workstation</i>	53
10.9.	<i>Setting Up the Handy Terminal.....</i>	54
10.10.	<i>Communicating with the Handy Terminal</i>	54
10.11.	<i>Synchronizing with the Host Workstation.....</i>	54
10.12.	<i>Exploring the Terminal from the Workstation.....</i>	54
10.13.	<i>Adding Programs via ActiveSync</i>	55
10.14.	<i>Wireless Radios</i>	56
10.15.	<i>Connecting the Terminal to a Wireless Network.....</i>	56
10.16.	<i>WLAN (802.11b/g/n Radio).....</i>	57
10.17.	<i>Adding Programs from the Internet.....</i>	57
11.	BLUETOOTH HANDLER	58
11.1.	<i>Enabling the Bluetooth Radio.....</i>	58
11.2.	<i>Connecting to Other Devices</i>	58
11.3.	<i>Pairing Bluetooth Devices</i>	58
11.4.	<i>Setting Up a Bluetooth Printer</i>	59
12.	SINGLE SLOT DOCKING CRADLE/SINGLE SLOT ETHERNET CRADLE DEVICE.....	59
12.1.	<i>Overview</i>	59
12.2.	<i>Battery Charging</i>	59

12.3.	<i>Power Supply</i>	59
12.4.	<i>Front Panel</i>	60
12.5.	<i>Back Panel</i>	60
12.6.	<i>Powering the Single Slot Docking Cradle or Single Slot Ethernet Cradle Device</i>	61
12.7.	<i>Charging the Main Battery</i>	62
12.8.	<i>Inserting a Terminal</i>	62
12.9.	<i>Charging a Spare Battery</i>	62
12.10.	<i>Charging Backup Battery</i>	63
12.11.	<i>Technical Specifications</i>	63

1. Introduction

Thank you for purchasing PM260 handy terminal.
This manual generally provides you with the safety information and basic features and operations of the PM260 device. Please read all safety precautions and this manual carefully before using your handy terminals and peripherals to ensure safe and proper use.

Trademarks

The official name of Windows XP is Microsoft Windows XP Operating System.
The official name of Windows Vista is Microsoft Windows Vista Operating System.
The official name of Windows 7 is Microsoft Windows 7 Operating System.
Microsoft, Windows, Windows Embedded CE 6.0 Pro, ActiveSync, and the brand names and product names of other Microsoft products are trademarks of Microsoft Corporation in the US and other countries.
Other company and product names given in this manual or displayed in this software may be the trademarks of their respective companies.

About the PM260 Handy Terminal

The new PM260 is the latest generation handy terminal device, combining a pocket sized rugged form factor built on Microsoft Windows Embedded CE 6.0 Pro operating system. The PM260 is designed for retail warehousing and logistics applications where maximum performance and durability is required in compact handheld device.

The PM260 handy terminal is available in different models depending on the options.

- 1D-Laser model

Bluetooth v2.0, 802.11 b/g/n, 1D Laser Scanner, Windows Embedded CE 6.0 Pro, 128MB RAM/128MB Flash
- 2D-Imager model

Bluetooth v2.0, 802.11 b/g/n, 2D Imager, Windows Embedded CE 6.0 Pro, 128MB RAM/128MB Flash

Accessories

- **Cradles**
260-HB Single Slot Docking Cradle
260-EHB Single Slot Ethernet Cradle
- **Batteries**
2,200mAh Battery Pack, Standard Capacity
3,300mAh Battery Pack, High Capacity with Battery Cover
- **Power Supply**
AC Adaptor, INPUT: AC100-240V 50/60Hz, OUTPUT: DC5V 2A
- **Cables**

USB ActiveSync Cable

□ **Others**

Belt Clip

Hand Strap

Stylus Pen

PM260 handy terminal contains the following items basically:

- Handy terminal
- Battery Pack
- Stylus Pen with Hand Strap
- Belt Clip
- 5V/2A AC Adaptor
- AC Plugs
- LCD Screen Protector
- EULA sleeve

 **NOTE:** Keep the original packaging for use when sending products to the technical assistance center. Damage caused by improper packaging is not covered under the warranty

 **NOTE:** Rechargeable battery packs are not initially charged or discharged. Before you begin to use, you must charge the battery packs first. See Paragraph 3.2.

2. Safety Regulations

Symbols in this manual

In this manual, some important items are described with the symbols shown below. Be sure to read these items before using this equipment.

 **WARNING** Indicates a potentially hazardous situation which, if not avoided, could result in death serious injury, or serious damage, or fire in the equipment or surrounding objects.

 **CAUTION** Indicates a potentially hazardous situation which, if not avoided, may result in minor or moderate injury, partial damage to the equipment or surrounding objects, or loss of data.

 **NOTE** Indicates information to which you should pay attention when operating the equipment.

This section outlines the safety precautions associated with using PM260 handy terminal.

 **NOTE:** PM260 handy terminals meet or exceed the requirements of all applicable standards organizations for safe operation. However, as with any electrical equipment, the best way to ensure safe operation is to read this manual carefully before performing any type of connection to the handy terminal and operate them according to the agency guidelines described in the manual.

2.1. General Safety Rules

CAUTION

- Use only the components supplied by the manufacturer for the specific PM260 being used.
- Do not attempt to disassemble the PM260 handy terminal, as it does not contain parts that can be repaired by the user. Any tampering will invalidate the warranty.
- When replacing the battery pack or at the end of the operative life of the PM260 handy terminal, disposal must be performed in compliance with the laws in force in your country.
- Before using the devices and the battery packs, read this manual carefully.
- Do not submerge the PM260 handy terminal in liquid products.

2.2. Power Supply

The power supply for this device has met applicable UL/PSE/KCC/CE/CCC safety requirements. Please adhere to the following safety instructions per UL guidelines:

- FAILURE TO FOLLOW THE INSTRUCTIONS OUTLINED MAY LEAD TO SERIOUS PERSONAL INJURY AND POSSIBLE PROPERTY DAMAGE.
- IMPORTANT SAFETY INSTRUCTIONS – SAVE THESE INSTRUCTIONS.

WARNING

- DANGER – TO REDUCE THE RISK OF FIRE OR ELECTRIC SHOCK, CAREFULLY FOLLOW THESE INSTRUCTIONS.

Use only Pointmobile-approved power supply. Use of a non-Pointmobile-approved power supply may be dangerous and the warranty does not cover damage to the device caused by non-Pointmobile-approved power supply. The package includes international AC plug/s. The AC plug/s must be plugged in the power supply before the power supply itself is plugged on the wall outlet. The power supply is intended to be correctly oriented in a vertical or horizontal or floor mount position.

2.3. Laser Safety

CAUTION

A Class 2 laser is safe because the blink reflex limit the exposure to no more than 0.25 seconds. It only applies to visible-light lasers (400–700 nm). Class-2 lasers are limited to 1mW continuous wave, or more if the emission time is less than 0.25 seconds or if the light is not spatially coherent. Although staring directly at the laser beam momentarily causes no known biological damage, avoid staring at the beam as one would with any very strong light source, such as the sun. Avoid that the laser beam hits the eye of an observer, even through reflective surfaces such as mirrors, etc. The laser light is visible to the human eye and is emitted from the window indicated in the figure.



Laser Light Label

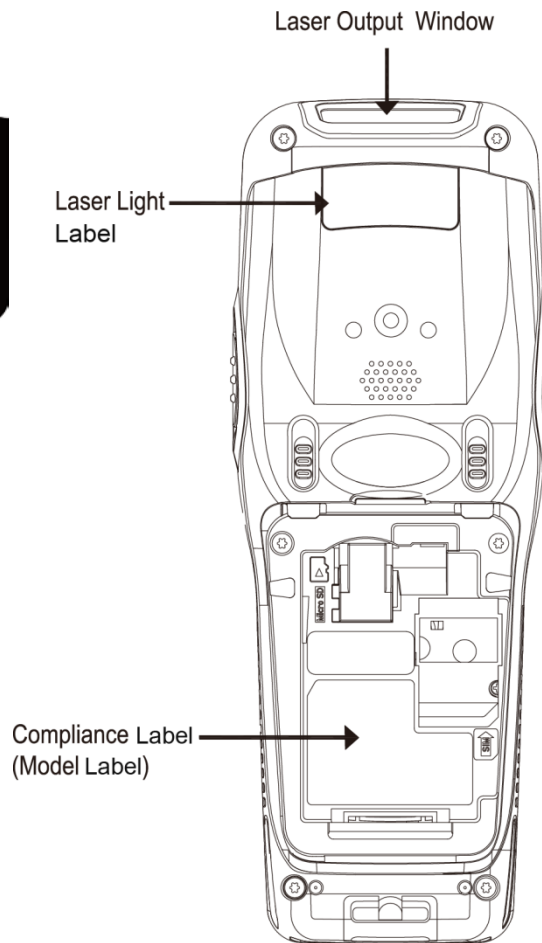



If the above laser light label is attached to your device, it indicates the product contains a laser engine or laser aimer that emits the laser light. The following information is provided to comply with the rules imposed by international authorities and refers to the correct use of PM260 handy terminal.

Laser Safety Statement

This product has been tested in accordance with and complies with CDRH 21 CFR 1040.10 and 1040.11 and IEC 60825-1 Ed 2 (2007) except for deviations pursuant to Laser Notice No 50, dated June 24, 2007. LASER LIGHT. DO NOT STARE INTO BEAM. CLASS 2 LASER PRODUCT. 1 mW MAX OUTPUT: 650nm.

For installation, use and maintenance, it is not necessary to open the device.

- 
WARNING: Do not attempt to open or otherwise service any components in the optics cavity. Opening or servicing any part of the optics cavity by unauthorized personnel may violate laser safety regulations. The optics system is a factory only repair item.
- 
WARNING: Use of controls or adjustments or performance of procedures other than those specified herein may result in exposure to hazardous visible laser light.
- 
WARNING: Use of optical systems with the scanner will increase eye hazard. Optical instruments include binoculars, microscopes, eye glasses and magnifying glasses.

2.4. LED Safety

The LED output on this device has met IEC62471 LED safety and certified to be under the limits of a CLASS 1 LED product.

2.5. FCC RF Exposure

This device complies with FCC RF exposure guidelines set forth for an uncontrolled environment.

2.6. CB Scheme

This device complies with CB Scheme IEC 60950-1

2.7. FCC Part 15 Regulation

Pursuant to part 15 of the FCC Rules, you are cautioned that changes or modifications not expressly approved by Pointmobile could void your authority to operate the PM260 handy terminal.

This device complies with part 15 of the FCC Rules. Operation is subject to the following two conditions: (1) This device may not cause harmful interference, and (2) this device must accept any interference received, including interference that may cause undesired operation.

This device has been tested and found to comply with the limits for a Class B digital device, pursuant to Part 15 of the FCC Rules. These limits are designed to provide reasonable protection against harmful interference in a residential installation. This equipment generates, uses and can radiated radio frequency energy and, if not installed and used in accordance with the instructions, may cause harmful interference to radio communications. However, there is no guarantee that interference will not occur in a particular installation. If this equipment does cause harmful interference to radio or television reception, which can be determined by turning the equipment off and on, the user is encouraged to try to correct the interference by one or more of the following measures:

- Reorient or relocate the receiving antenna.
- Increase the separation between the equipment and receiver.
- Connect the equipment into an outlet on a circuit different from that to which the receiver is connected.
- Consult the dealer or an experienced radio/TV technician for help.

In accordance with FCC 15.21, changes or modifications not expressly approved by the party responsible for compliance could void the user's authority to operate the equipment.

The antenna(s) must not be co-located or operating in conjunction with any other antenna or transmitter. To maintain compliance with FCC RF exposure guidelines for body-worn operation, do not use accessories that contain metallic components.

2.8. Canadian Compliance

This radio transmitter has been approved by Industry Canada to operate with the antenna types listed below with the maximum permissible gain and required antenna impedance for each antenna type indicated. Antenna types not included in this list, having a gain greater than the maximum gain indicated for that type, are strictly prohibited for use with this device.

Under Industry Canada regulations, this radio transmitter may only operate using an antenna of a type and maximum (or lesser) gain approved for the transmitter by Industry Canada. To reduce potential radio interference to other users, the antenna type and its gain should be so chosen that the equivalent isotropically radiated power (e.i.r.p.) is not more than that necessary for successful communication.

This device complies with Industry Canada license-exempt RSS standard(s). Operation is subject to the following two conditions: (1) this device may not cause interference, and (2) this device must accept any interference, including interference that may cause undesired operation of the device.

Le présent émetteur radio a été approuvé par Industrie Canada pour fonctionner avec les types d'antenne énumérés ci-dessous et ayant un gain admissible maximal et l'impédance requise pour chaque type d'antenne. Les types d'antenne non inclus dans cette liste, ou dont le gain est supérieur au gain maximal indiqué, sont strictement interdits pour l'exploitation de l'émetteur.

Conformément à la réglementation d'Industrie Canada, le présent émetteur radio peut fonctionner avec une antenne d'un type et d'un gain maximal (ou inférieur) approuvé pour l'émetteur par Industrie Canada. Dans le but de réduire les risques de brouillage radioélectrique à l'intention des autres utilisateurs, il faut choisir le type d'antenne et son gain de sorte que la puissance isotrope rayonnée équivalente (p.i.r.e.) ne dépasse pas l'intensité nécessaire à l'établissement d'une communication satisfaisante.

Le présent appareil est conforme aux CNR d'Industrie Canada applicables aux appareils radio exempts de licence. L'exploitation est autorisée aux deux conditions suivantes : (1) l'appareil ne doit pas produire de brouillage, et (2) l'utilisateur de l'appareil doit accepter tout brouillage radioélectrique subi, même si le brouillage est susceptible d'en compromettre le fonctionnement.

2.9. Radio Compliance

PM260 RF terminals are in conformity with all essential requirements of the R&TTE Directive (1999/5/EC).

This device is marked with **CE0984** in accordance with the Class II product requirements specified in the R&TTE Directive, 1999/5/EC. The device is intended for use throughout the European Community; PAN European Frequency Range: 2.402 ~ 2.480 GHz.

Restrictions for use in France are as follows:

- Indoor use: maximum power (EIRP*) of 100 mW for the entire 2.400 ~ 2.4835 GHz
- Outdoor use: Maximum power (EIRP*) of 100 mW for the 2.400 ~ 2.454 GHz band and maximum power (EIRP*) of 10 mW for the 2.454 ~ 2.483 GHz band.

CE The CE mark on the device indicates that the system has been tested to and confirm with the provisions noted within the 2004/108/EC Electromagnetic Compatibility Directive and the 2006/95/EC Low Voltage Directive, 1999/5/EC (R&TTE), and 2011/65/EU (RoHS). Pointmobile shall not be responsible for use of our product with equipment (i.e., power supplies, personal computers, etc.) that is not CE marked and does not comply with the Low Voltage Directive.

2.10. WEEE Compliance

Information for the user in accordance with the European Commission Directive 2012/19/EU of the European Parliament and of the Council of 4 July 2012 on Waste Electrical and Electronic Equipment (WEEE)

This product has required the extraction and use of natural resources for its production. It may contain hazardous substances that could impact health and the environment, if not properly disposed. In order to avoid the dissemination of those substances in our environment and diminish the pressure on the natural resources, we encourage you to reuse, recycle and recover the product. If the product is disposed according to the Directive, it will avoid potentially negative consequences to the environment and human health which otherwise could be caused by incorrect disposal.



The product marked with crossed out wheeled bin must be disposed separately from municipal waste.

For more detailed information about disposal, reuse, and recycle system, contact your local or regional waste administration.

2.11. China Compliance

This device complies with Highland and Tropical environment requirements of the CCC GB4943.1 (2011).

This device is marked with  in accordance with the Highland product requirements specified in the CCC GB4943.1(2011) and complies with the followings:



仅适用于海拔2000m及以下地区安全使用

Apply only to the use at the locations up to altitude 2000m for safety use.

3. Getting Started

3.1. Install the Battery

The HANDY TERMINAL is shipped with the battery packaged separate from the unit. Follow the steps below to install the battery.

1. Release the strap making it convenient to reach the door.
2. Remove the battery compartment door by moving the door's locks upward and removing the door.

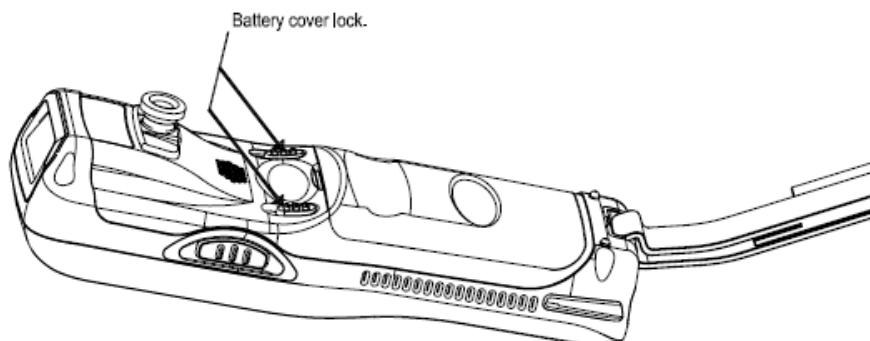

3. Insert the battery into the battery well with the labels facing upward.

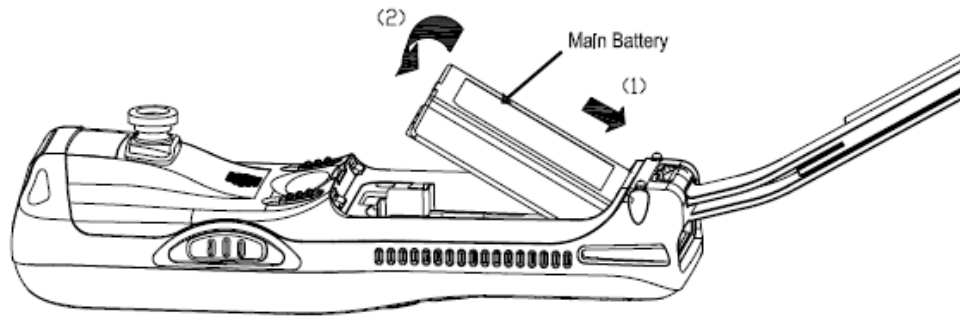

4. Replace the battery door with a hinging motion and move the door's lock downwards.

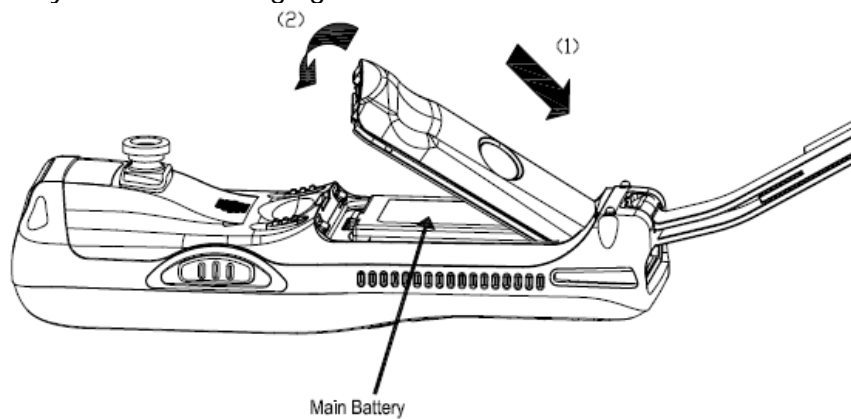

NOTE: The battery door must be installed prior to booting the unit.

5. Tighten the hand strap.

WARNING: Use only Pointmobile-approved Li-Ion battery packs. Unauthorized battery may result in damage not covered by the warranty.

3.2. Charge the Batteries

Handy Terminals ship with both the main battery pack and internal backup battery significantly discharged of power. Charge the main battery pack with the Handy Terminal charging cable for a **minimum of 4 or 6 hours depending on your battery before initial use.**

1. Attach the appropriate plug adapter to the plug of the power cable.

2. Insert the plug into the appropriate power source.

Plug the Handy Terminal power cable into the DC Power Jack on the bottom end of the unit.

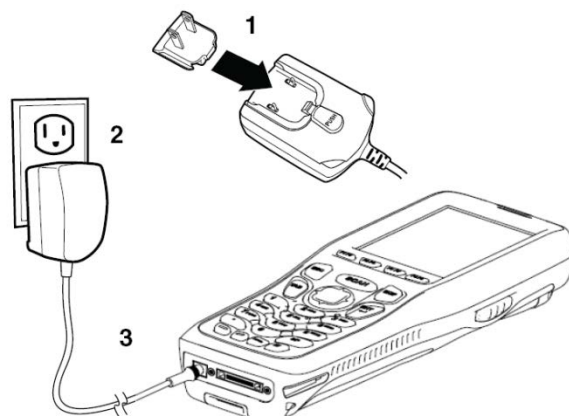



WARNING: Use only Pointmobile-approved peripherals, power cables, and power adapters. Unauthorized peripherals, cables, or power adapters may cause batteries to explode or damage your device. DO NOT attempt to charge damp/wet handy terminals or batteries. All components must be dry before connecting to an external power source. Batteries must be charged at a temperature ranging from 3~42°C (±3°C). If you don't follow the guide, it might have a harmful effect on the battery life.



CAUTION: After the battery has been charged, disconnect the DC Power Jack from the terminal. If you stay on that plug in use, it is possible to break the power code.



NOTE: Rechargeable battery packs are not initially charged. Therefore the first operation to perform is to charge them.



NOTE: If you remove the battery pack or it completely discharges, you have 30 minute window of time to insert a charged battery pack before the backup battery completely discharges. If your backup battery completely discharges, the contents of the RAM memory will be lost. If the backup battery is less than fully charged, there is a proportionally smaller window of time available.

3.3. LED Indicators

The red LED is ON while charging the battery and the green LED is ON when the battery is fully charged.

Alternatively, it is also possible to recharge the battery pack by using the single slot docking cradle, the single slot Ethernet cradle or the 4-slot battery charger.

During the charging process the LED positioned at the right upper side of the display is red constant. Once the charging process has been completed this LED is green constant.

If the battery pack is removed from the handy terminal, it can be recharged by inserting it into the rear slot of the single slot docking cradle, the single slot Ethernet cradle or the 4slot battery charger.

3.4. Guidelines for Battery Pack Use and Disposal

The following are general guidelines for the safe use and disposal of batteries:

- Store the terminal and the spare batteries between 20 to 30 °C (68 to 86 °F) in order to maintain optimal battery performance.
 - High capacity batteries must be charged at a temperature ranging from 3~42°C(±3°C).
- Standard batteries must be charged at a temperature ranging from 3~42°C(±3°C).
- The battery level may not be displayed correctly for some minutes after the disconnection if the handy terminal is disconnected from power supply before the charging cycle is completed.
- The handy terminal could get warm during charging. This is normal and does not mean a malfunction.
- To achieve the best battery life, turn off the radios not in use.
- Rechargeable backup batteries and battery packs are not initially charged. Therefore the initial operation to perform is to charge them. See below.
- By default, the battery pack is disconnected at the factory to avoid damage due to excessive draining. Annual replacement of rechargeable battery pack avoids possible risks or abnormalities and ensures maximum performance.



WARNING: DO NOT attempt to charge damp/wet handy terminals or batteries. All components must be dry before connecting to an external power source.



WARNING: Never throw a used battery in the trash. It contains heavy metals and should be recycled according

to local guidelines.



WARNING: Storage of batteries for long time at fully charged status or at fully discharged status should be avoided.

Only in case of long storage, in order to avoid deep discharge of the battery, it's recommended to partially recharge the battery every two-three months to keep the charge status at a medium level.



WARNING: Installing, charging and/or any other action should be done by authorized personnel and following this manual.

The battery pack may get hot, explode, ignite, and/or cause serious injury if exposed to abusive conditions.

If the battery pack is replaced with an improper type, there is risk of explosion.

Do not place the battery pack in or near a fire or heat; do not place the battery pack in direct sunlight, or use or store the battery pack inside unventilated areas in hot weather; do not place the battery pack in microwave ovens, dryer, high pressure containers, on induction cookware or similar device. Doing so may cause the battery pack to generate heat, explode or ignite. Using the battery pack in this manner may also result in a loss of performance and a shortened life expectancy.

Use only a Pointmobile approved power supply. The use of an alternative power supply will void the product warranty, may cause product damage and may cause heat, explode or ignite.

The area in which the units are charged should be clear of debris and combustible materials or chemicals.

Do not use the battery pack in any other manner outside its intended use in Handy Terminal and peripherals.



WARNING: Immediately discontinue use of the battery pack if, while using, charging or storing the battery pack, the battery pack emits an unusual smell, feels hot, changes colour or shape, or appears abnormal in any other way.

Do not short-circuit the battery pack contacts connecting the positive terminal and negative terminal. This might happen, for example, when you carry a spare battery pack in your pocket or purse; accidental short-circuiting can occur when a metallic object such as a coin, clip, or pen causes direct connection of the contacts of the battery pack (these look like metal strips on the battery pack). Short-circuiting the terminals may damage the battery pack or the connecting object.

Do not apply voltages to the battery pack contacts.

Do not pierce the battery pack with nails, strike it with a hammer, step on it or otherwise subject it to strong impacts or shocks.

Do not disassemble or modify (i.e. bend, crush or deform) the battery pack. The battery pack contains safety and protection devices, which, if damaged, may cause the battery pack to generate heat, explode or ignite.

In case of leakage of liquid from the battery, avoid contact with liquid the skin or eyes. If the contact occurs, immediately wash the affected area with water and consult a doctor.

Do not solder directly onto the battery pack.

Do not expose the battery pack to liquids.

Avoid any knocks or excessive vibrations. If the device or the battery is dropped, especially on a hard surface, you should take it to the nearest Authorised Repair Centre for inspection before continuing to use it.

Do not replace the battery pack when the device is turned on.

Do not remove or damage the battery pack's label.

Do not use the battery pack if it is damaged in any part.

Battery pack usage by children should be supervised.

Collect and recycle waste batteries separately from the device in comply with European Directive 2006/66/EC, 2011/65/EU, 2012/19/EU and subsequent modifications, US and China regulatory and others laws and regulations about environment.



NOTE: In order to guarantee an adequate operating autonomy, when replacing the battery pack the handy

terminal checks the battery energy level. If the battery is not sufficiently charged, handy terminal does not turn on.

In this case, either substitute the battery pack with a charged one (sufficiently charged) or insert handy terminal into a powered cradle or plug it into the direct power supply.

3.5. Turn Your Device On

If you apply the power to your device, it turns on by itself. Do NOT press any keys or interrupt while

turning on process.

When the process is complete, the Desktop appears, and the terminal is ready for use.

3.6. Desktop

NOTE: You can access the Desktop any time by tapping the Change Views icon in the command bar and selecting Desktop on the popup menu









Tab to change views







3.7. Indicator Icons

The command bar, located at the bottom of application screens, provides access to many system functions and programs.



Left and right arrows are used to scroll through additional icons

Icon	Meaning
	Opens the Start menu.
	Changes views between open applications or returns to the Desktop.
	Accesses the Bluetooth radio. Double tap this icon to open the Bluetooth Handler (see Paragraph 11).
	Shows signal strength of WLAN radio. (A red X indicates the terminal is not currently associated to an AP.)
	Indicates that WiFi or Ethernet cradle turn on but not connected.
	Indicates that the USB communication cable is connected. Double tap to display USB status window.
	Open the detail option.

	Indicates the status of battery power. Double tap to open the Power control panel setting.
	When this icon shows a red power plug, it indicates the device is using external power.
	Displays the current time. Double tap to change the time and date.
	Indicates whether the keypad is standard alpha (upper and lower case), all caps alpha, or in numeric mode. Press the ALPHA button on the keypad to switch modes.
Icon	Meaning
	The up arrow allows you to turn the Wireless LAN and Bluetooth connection on or off. It also allows you to toggle between the Keypad and Transcriber. When Keypad is selected, a keypad is displayed so you can tap text and number keys. Transcriber recognizes handwriting and symbols entered using the stylus.
	Indicates Blue mode.
	Indicates Red mode.

3.8. Using the Stylus

The terminal comes with a stylus included in a loop on the hand strap. Use this stylus (or your finger) to select or enter information on the touch screen. The stylus functions as a mouse; generally, a tap is the same as a click.

Tap Tap the touch screen once or double tap to open menu items and select options.

Drag Hold the stylus on the screen and drag across the screen to select text and images.

Tap & hold Tap and hold the stylus on an item and a pop-up menu appears. On the pop-up menu, tap the action of the task you want to perform.

 **WARNING:** Use of objects, such as paper clips, pencils, or ink pens on the touch screen can damage the input panel and may cause damage not covered by the warranty.

3.9. Selecting Program

Tap **Start -> Programs**. To open a program, tap the icon on the menu.

3.10. Pop-Up Menus

You can quickly choose an action for an item using the pop-up menus.

1. Tap and hold the stylus on the item name. The pop-up menu appears.
2. Lift the stylus and tap the action you want to perform.

The contents of pop-up menus change according to the program you are using.

3.11. Using Windows Explorer

Use Windows Explorer to navigate through the files on your system. On the desktop, double tap the **My Device** icon and Windows Explorer opens to the root level.



Move files by tapping and holding on the file, then tapping **Cut**, **Copy** or **Paste** on the pop-up menus that appear.

4. Get to Know Your Device

4.1. Feature of Your Device

The following list outlines a few of the feature included in your device.

4.2. PM260 Handy Terminal

- Operating Systems: Microsoft Windows Embedded CE 6.0 Pro
- Micro Processor: Marvell® PXA300 624MHz
- RAM Memory: 128MB SDRAM
- FLASH Memory: 128MB NAND
- 2.8" QVGA Display: 240x320 65KColor Transmissive TFT
- Resistive Industrial Grade Touch Screen
- Keyboards: Numeric, 29-key pad
- Micro SDHC Expansion Memory Card Interface: Support up to 32 GB
- DC-Jack: Support wall mount charging
- I/O connector: USB 2.0 Full speed (Host and Client), Charging, UART
- Scan Engine:
 - 1D Laser : N4313
 - 2D Imager: IT5300SR
- Battery:
 - Standard: Li-ion battery, 3.7V/2200mAh/8.1Wh
- IP65 certified enclosures
- Audio: Integral Microphone, Speaker

- BT: Bluetooth Radio with Internal Antenna
- WLAN: 802.11 b/g/n Radio with Internal Antenna (5GHz bands are not supported.)
- Notification LEDs
 - 1) Power indications, 2) Warning indications, 3) Scan reading indications
- Notification Vibration Motor

4.3. Front Panel Layout

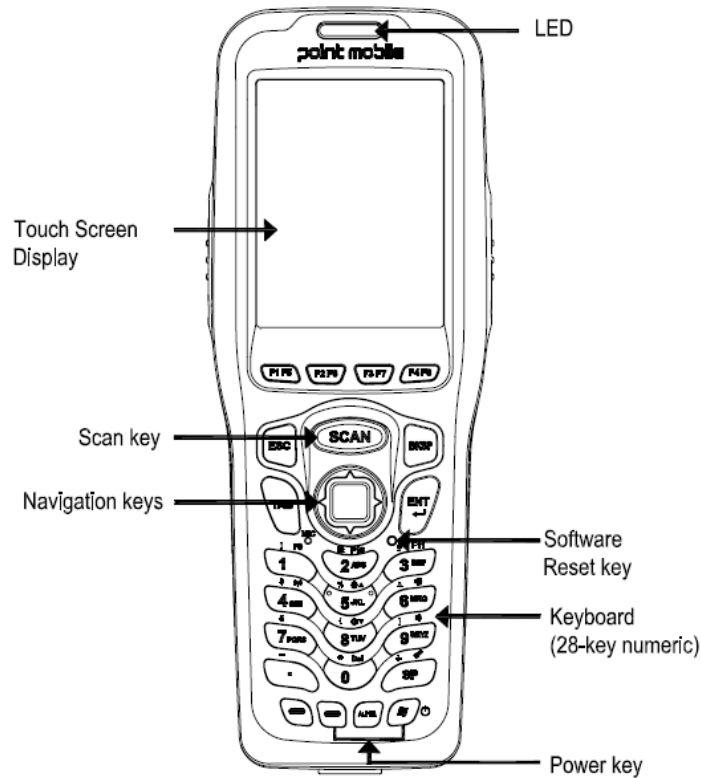

LED Indicator

Shows the information needed to operate your device as follows:

Note: The LED is user-programmable.

LED Color	Meaning
Red	Lights when a scan fails. Lights when main battery is charging.
Green	Lights when scanned bar code is successfully decoded. Lights when main battery charging has completed.
Blue	Flashes during a Soft Reset. Periodic flashing while system booting and kernel updating.
Red	Flashes during a Hard Reset

Keypad

A 29 numeric keypad (includes side scan buttons).

Microphone

The integrated microphone can be used for audio recording.

Touch Screen Display

The display is a LCD (Liquid Crystal Display) with a 4-wire analog resistive touch screen. The 2.8" (1/4) VGA (Video Graphic Array) is transmissive active matrix color and backlit. The resolution is 240 x 320; see Display Backlight on paragraph 4.4.

For touch screen input, use the stylus included with the terminal or your finger. The method you choose depends on which one is most appropriate for your application. While there is a great deal of variation in different applications, you generally achieve greater accuracy with the stylus for buttons or icons that are close together.

 **WARNING:** Use of objects, such as paper clips, pencils, or ink pens on the touch screen can damage the input panel and may cause damage not covered by the warranty.

4.4. Display Backlight

The intensity of the backlight of the touch screen display may be changed, and the backlight may be programmed to turn off after the terminal has been idle for a specified period of time.

To adjust the intensity of the backlight while on battery power, tap **Start** -> **Settings** -> **Control Panel** -> double tap **Backlight**.

Screen Backlight - Battery/External Power

Move the slider to adjust the screen backlight while on battery power.

You may turn the screen backlight off if the device is not used for a designated period of time by checking the option and designating the desired time period.

You may also turn on the screen backlight when a button is pressed or the screen is tapped by selecting the appropriate checkbox.

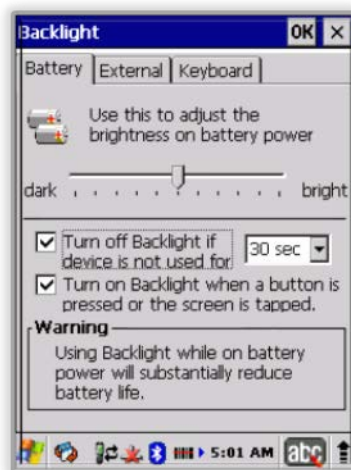

 **NOTE:** Using the backlight option while on battery power substantially reduces battery life.

You may make the same changes when on external power by tapping the **External** tab.

4.5. Keypad Backlight

To turn on the keypad backlight, check the checkbox.

The duration of backlight of keypad synchronizes with LCD backlight's.



4.6. Using Screen Protectors

Pointmobile defines proper use of the terminal touch panel display as using a screen protector and proper stylus. Screen protectors maintain the ongoing integrity (i.e., prevent scratching) of the touch panel, which is why their use is recommended for applications that require a high to medium level of interface with the touch panel.

Pointmobile also mandates use of the proper stylus, which is one that has a stylus tip radius of no less than 0.8mm. Use of the stylus included with the terminal is recommended at all times.

4.7. Installing Your Screen Protector

When installing a screen protector, use a flat plastic card (e.g., credit card) to apply the screen protector smoothly and remove any air bubbles.

1. Press the Power key to put the terminal in suspend mode.
2. Clean the touch panel thoroughly with a clean, non-abrasive, lint-free cloth, Make sure nothing is on the touch panel.
3. Blue tag with backing film: Peel off this mask before application.

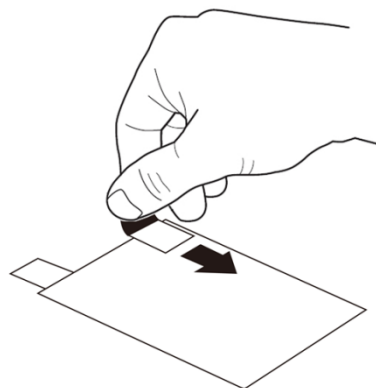

4. Align the exposed edge of the screen protector along the left edge of the touch panel.

Make sure that it lies flush with edges of the touch panel.

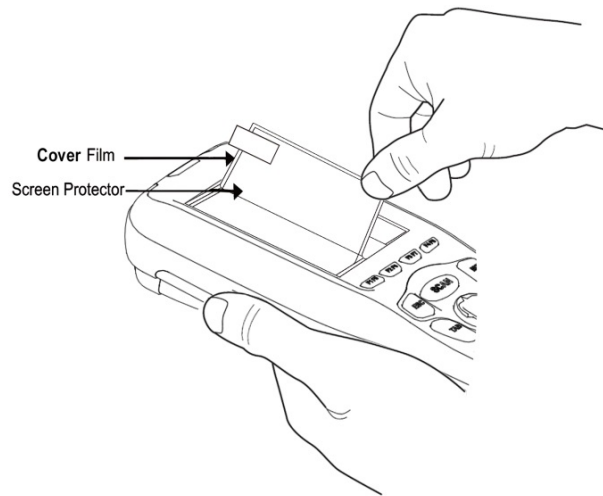

 **NOTE:** To reposition the screen protector, lift up gently and reapply.

5. Yellow tag with cover film: "Please peel off this mask after application completed.



6. Press gently but firmly. Use the card a necessary to smooth out any air pockets or bumps after allocation

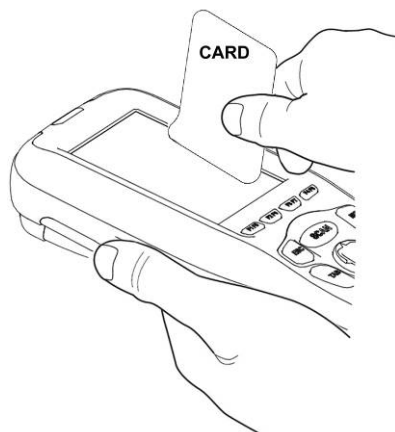

7. Press the Power key to wake the terminal and check the touch panel with the stylus.

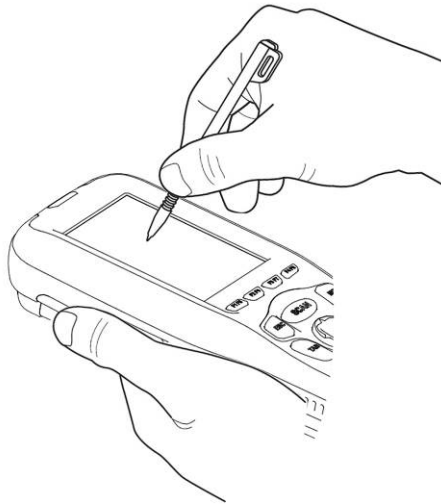

8. Verify that the screen accepts input from the stylus as usual. If not, re-apply the screen protector.
9. Press the Power key to put the terminal back in suspend mode.
10. Clean the surface of the screen protector with a clean, non-abrasive, lint-free cloth.
11. Press the Power key to wake the terminal again.
12. For maximum performance, recalibrate the screen. Tap Start > Settings > Control Panel > Double Tap Stylus > Calibrate tap.



13. Tap Recalibrate the follow the instructions on the screen.

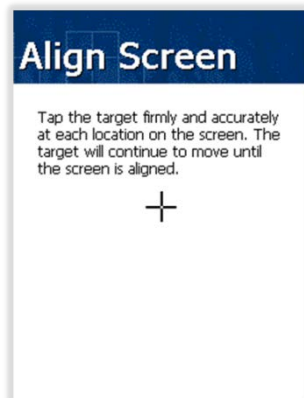

4.8. Back Panel Layout

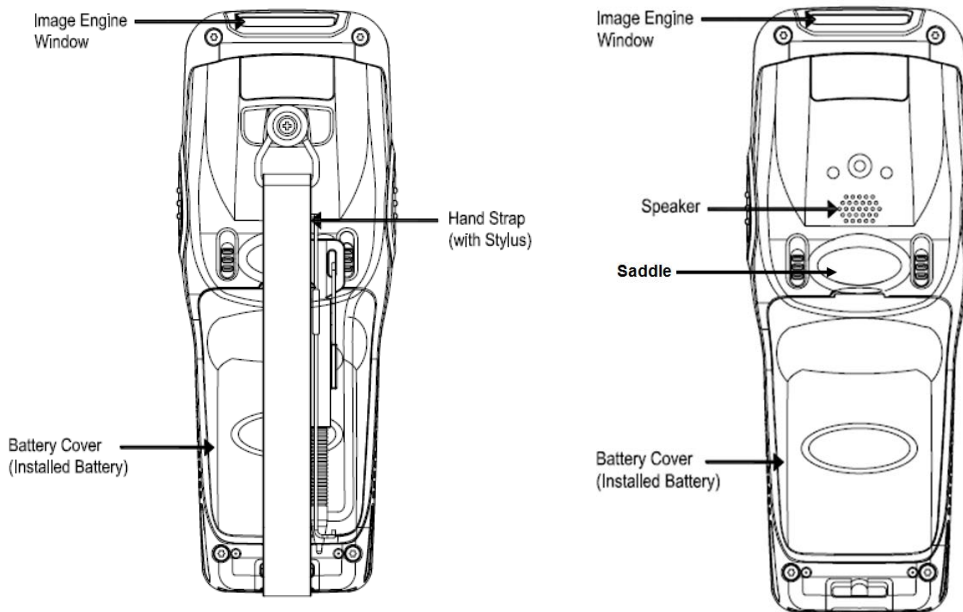

Hand Strap

The HANDY TERMINAL comes with an adjustable, elastic hand strap. You can attach it to the device.

Keep in mind that the hand strap covers the battery. When you want to replace the battery, you will need to adjust the hand strap accordingly.

Finger Saddle

This is a slightly depressed and angled area of the back housing that is designed to cradle or “saddle” your finger while holding the terminal. This unique ergonomic design makes the terminal comfortable to hold and helps prevent you from accidentally dropping the terminal.

Installed Battery

For information about installing the battery, see [Install the Battery](#) on paragraph 3.1. For information about battery power, see [Battery Power](#) on paragraph 4.17.

Speaker

The integrated speaker sounds audio signals as you scan bar code labels and enter data, but emits no ambient noise on system activity (i.e., processor, memory access, radio traffic, etc.). The speaker can also be used for playing sounds (e.g., WAV or MP3 files).

The speaker meets the following SPL levels at 10cm:

- 500Hz–80dB
- 1kHz–90dB
- 4kHz–90dB

Stylus

HANDY TERMINAL is shipped with a stylus inserted in a loop on the hand strap. Store the stylus in the hand strap when you’re not using it; see [Using the Stylus](#) on paragraph 3.8.

4.9. Left Side Panel Layout

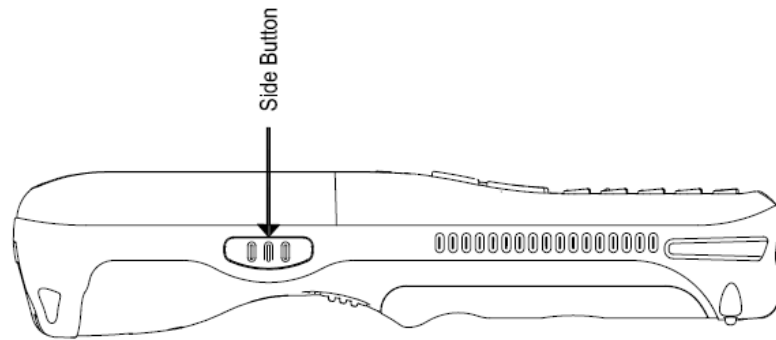

Side Button

There is a button like this on both side panels. You can use the Programs Buttons option in the Control Panel to change the functionality of the side buttons. Scan function is assigned by default.

4.10. Installing Memory Cards

The HANDY TERMINAL supports Micro Secure Digital (SD) memory cards up to 32GB. **Sandisk, Kingstone and ATP micro SD recommended**

To access the Micro SD card slot and insert the card, proceed as follows:

1. Press the **Power** key to put the terminal in Suspend Mode; see Suspend Mode on paragraph 4.23.
2. Remove the battery door on the back of the unit.
3. Remove the battery and open
4. Open the access door on SD slot in Battery well.
3. Insert the SD card with the label facing upward.

 **NOTE:** To remove an installed SD card while the access door is open, tap on the edge lightly to unlock the card; the card will pop out just enough for you to grab its edge and pull it out.

4. Replace the access door.
The rubber door is required for 1) proper functioning of the SD card and 2) preserving the environmental rating for water sealing. Do not remove the rubber door.

 **NOTE:** Do not use the terminal when the access door is open. When this door is fastened securely and properly, the memory interface is sealed against moisture and particle intrusion, read/write data is stored securely, and the terminal's environmental rating is preserved.

5. Tap the **Power** key to resume operation.
6. To verify that the operating system recognizes the new memory card, open Windows Explorer and navigate to My Device\Storage Card.

 **WARNING:** Follow proper ESD precautions to avoid damaging the SD. Proper ESD precautions include, but are

not limited to, working on an ESD mat and ensuring that the operator is properly grounded.

Do not force the card. If you feel resistance, remove the card, check the orientation, and reinsert it.

Do not use the Micro SD card slot for any other accessories.

It is highly recommended to lock the card holder even if the card is not present.

4.11. Right Side Panel Layout

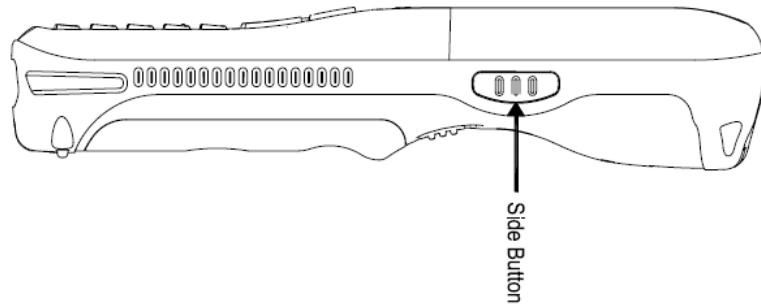

Side Button

There is a button like this on both side panels. You can use the Programs Buttons option in the Control Panel to change the functionality of the side buttons. Scan function is assigned by default.

4.12. Top Panel Layout

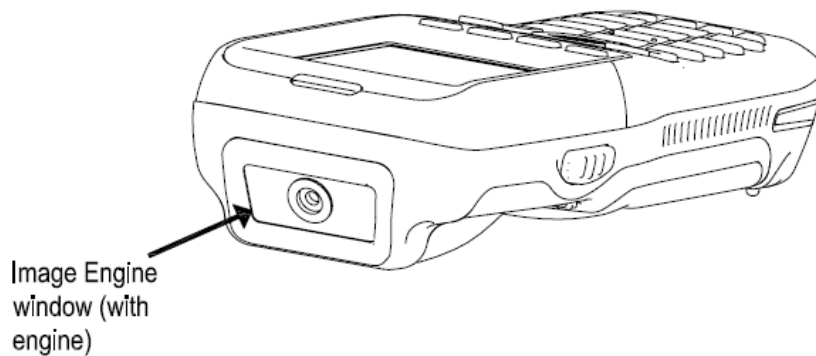
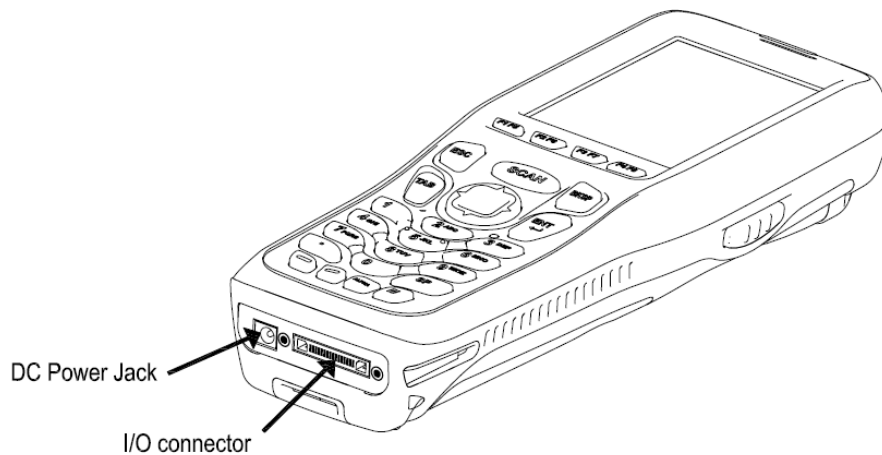

Image Engine Window

The angled image engine reads and decodes most popular bar code symbologies. For more information, see Using the Image Engine on paragraph 6.

4.13. Bottom Panel Layout



DC Power Jack

The DC power jack receives external power from the Handy Terminal power cable that is included with the terminal. When connected to the Handy Terminal power cable, the terminal is powered and the main battery pack is charging.

I/O Connector

The I/O mechanical connector is designed to work exclusively with HANDY TERMINAL peripherals and cables. This connector powers the terminal, charges the main battery, and facilitates communication. This connector supports full speed USB 2.0 communication (up to 12 Mbps) and RS-232 communications with a maximum speed of 115Kbps and seven baud rate settings.

Through this connector, you can communicate with a host workstation via Microsoft ActiveSync; see ActiveSync Communication on paragraph 10.4

The I/O connector supports the following signals:

Pin Description	Direction
DC IN +5V	IN
DC IN +5V	IN
RS-232 Transmitted Data	OUT
RS-232 Request To Send	OUT
USB Host +5V	OUT
USB Host D+	IN/OUT
USB Host D-	IN/OUT
USB Host Detect	IN
RS-232 Clear To Send	IN
RS-232 Received Data	IN
GND	
GND	
RS-232 ShutDown	IN
USB Client D+	IN/OUT
USB Client D-	IN/OUT
USB Client +5V	IN

 **NOTE:** Signals referenced are for a DTE device.

4.14. Peripherals and Accessories

The following items are sold separately and enhance your HANDY TERMINAL's capabilities.

Single Slot Docking Cradle

This charging and communication cradle supports USB and RS-232 communication, enabling your terminal to interface with the majority of enterprise systems. When a terminal is seated in a powered base, its main battery pack charges in four hours for the standard capacity 2200mAh pack and in six hours for the high capacity 3300mAh pack.

A spare battery may also be charged in the battery charging well behind the terminal.

For more information, see Single Slot Docking cradle/Single Slot Ethernet cradle Device on paragraph 12.

Single Slot Ethernet Cradle

The Single Slot Ethernet cradle is used to charge the main battery, to power the battery charging system in the terminal, and can be used to communicate data from the terminal to a PC/laptop via the Ethernet port.

A spare battery may also be charged in the battery charging well behind the terminal.

For more information, see Single Slot Docking cradle/Single Slot Ethernet cradle Device on paragraph 12.

4.15. USB ActiveSync Cable

The USB ActiveSync Cable is used when communicating between the terminal and a host computer to transfer data via the USB interface.

4.16. Li-ion Battery Packs

The Li-ion battery pack provides the main power supply for the terminal.

4.17. Battery Power

The intelligent battery technology inside the terminal features two types of battery power:

- The main battery pack
- The backup battery located inside the terminal

Both batteries work together to prevent data loss when the terminal is used over long periods of time.

Both batteries must be charged to full capacity before using the HANDY TERMINAL for the first time!

Charge the main battery pack with the Handy Terminal charging cable for **a minimum of 4 or 6 hours depending on your battery before initial use.**

4.18. Main Battery Pack

There are two Li-ion battery packs available for the HANDY TERMINAL:

Standard Capacity: Li-ion 3.7V/2200mAh/8.1Wh

High Capacity: Li-ion 3.7V/3300mAh/12.2Wh

The Li-ion battery pack is the primary power source for the Handy Terminal as well as for the internal backup battery.

Changing the Main Battery Pack

Before installing a battery pack, press the Power key to put the terminal in Suspend Mode so that operations are suspended before removing the main power source. Always put the terminal in Suspend Mode prior to changing the battery. The HANDY TERMINAL is shipped with the battery separate from the unit. You will need to loosen the hand strap, remove the battery door, insert the battery, and replace the battery door.

 **NOTE:** The battery door must be installed prior to booting the unit.

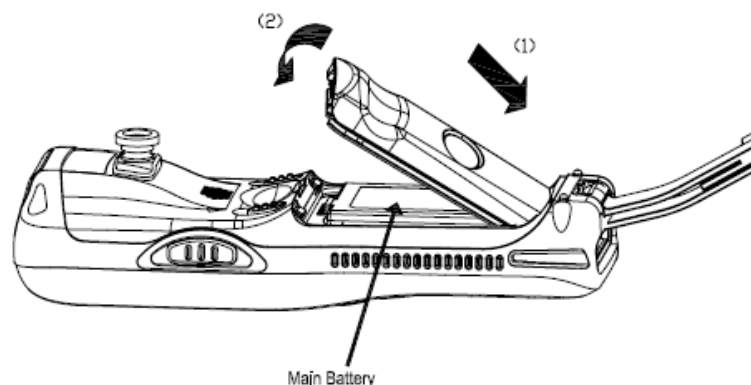

Charging Options

When the battery is installed in the terminal, you can use any of the peripherals listed below to charge the battery.

- AC Power Supply to DC Power Jack direct.
- Single slot docking cradle/Single slot Ethernet cradle
- Insert the battery in the spare battery charging well in the back of either the Handy Terminal Docking cradle or Handy Terminal Ethernet cradle.

Charging Time

The standard capacity 2200mAh Li-ion battery pack requires four hours to charge to full capacity, while the high capacity 3300mAh pack requires six hours.

4.19. Managing Main Battery Power

Data and files saved on the Handy Terminal may be stored in RAM memory; therefore, maintain a continuous power supply to the terminal to help prevent data loss. When you remove a battery pack, insert another charged battery pack in the Handy Terminal. If the main battery pack is low, insert the terminal into a charging peripheral to power the terminal and begin recharging the battery.

NOTE: If the main battery is low and the terminal is in Suspend Mode, pressing the **Power** button does **not** wake the HANDY TERMINAL; you must replace the discharged battery with a fully charged battery or apply AC power to the terminal.

Checking Battery Power

Power icons appear in the command bar at the bottom of the window. Double tap the battery icon to open the Power Properties. The Battery tab opens displaying the charge status of both the main and backup batteries.

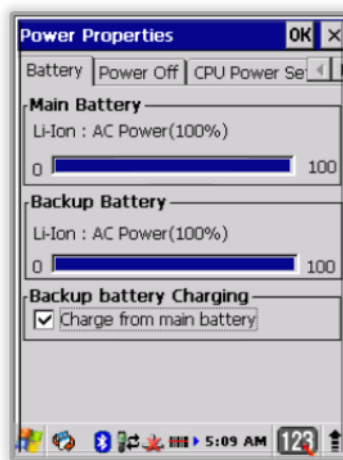

NOTE: You can also check battery power by tapping **Start -> Settings -> Control Panel -> double tap Power**.

4.20. Storage Guidelines

To maintain optimal battery performance, follow these storage guidelines:

- Avoid storing batteries outside the specified range of -4 to 104° F (-20 to 40°C) or in extremely high humidity.
- For prolonged storage, it is recommended that the battery be at a 40% - 50% charge level, be removed from the device, and stored in a controlled temperature environment. Following these recommendations will maximize battery life.

4.21. Internal Backup Battery

Located inside the terminal, the backup battery is a 3.7V Lithium Polymer battery.

The internal backup battery prevents the terminal from being reset when you remove the main battery pack. This backup battery retains RAM data and allows the real-time clock to remain operational for at least 24 hours. If the terminal is left without the main battery pack for more than 24 hours, the internal backup battery discharges and needs to be recharged to function according to specifications.

 **NOTE:** Even if the internal backup battery fails, data and programs stored in Flash memory (mounted as root directory) or on an optional SD card are not lost. However, the terminal automatically cold boots when you install a fully charged battery pack, and you need will to reset the Real-Time Clock.

Charging

The internal backup battery charges off the main battery pack and requires 2 hours charge time to backup RAM data for 24 hours. You can begin using the Handy Terminal after charging the main battery for four or six hours (depending upon your battery); however, the internal backup battery will continue to charge off the main battery.

To ensure that the internal backup battery functions properly, maintain a consistent power supply for the first eight hours of terminal operation. This power supply can be external power (using a charging peripheral) or an installed, charged battery pack or a combination of both.

4.22. Resetting the Terminal

Soft Reset: Using the stylus press and release the **Reset** button. This resets RAM and reloads the OS.

Hard Reset: Using the stylus press and hold the **Reset** button and then press and release the **Power** button. This resets RAM, reloads the OS, and resets the Real Time Clock.

Soft Reset (Warm Boot)

A soft reset re-boots the terminal without losing RAM data, terminates all running applications, reloads the OS, and launches Autoinstall, which re-initializes any CAB or REG files in **\AutoInstall\Cabfile** folder.

You would perform a soft reset 1) when the terminal fails to respond, 2) after installing software applications that require a reboot, or 3) after making changes to certain system settings, or 4) to install new CAB or REG files.

1. Press the **Reset** button. The screen turns white and the decode and scan LED flashes blue for approximately 10 seconds.
2. When the reset is complete, the Desktop appears.

Hard Reset (Cold Boot)



CAUTION: A hard reset erases all of the data and applications stored in RAM memory, reloads the OS, resets the Real Time Clock (RTC) and launches Autoinstall, which installs any CAB or REG files in the **\AutoInstall\Cabfile**.

Hard resets automatically launch a soft reset as part of the boot process if there are CAB files present.

1. Press and hold the **Reset** button and then press and release the **Power** button. The screen turns white and the decode and scan LED flashes red for approximately 20 seconds.
2. The terminal re-initializes, which re-installs all programs stored in the **\Autoinstall\Cabfile** folder.

 **NOTE:** Set the time and date after each hard reset to ensure that the system clock is accurate. Double-click the date on the command bar to open the Clock setting and set the time and date.

4.23. Suspend Mode

Suspend Mode suspends terminal operation. The terminal appears to be "off" when in Suspend Mode. The terminal is programmed to go into Suspend Mode automatically when inactive for a

specified period of time. You can set this time period in the Power setting.

To suspend and resume operation, press the **Power** button. You may also press the front Scan key to wake a suspended device unless the battery door has been removed and replaced.

NOTE: You should always put the terminal in Suspend Mode when you change the battery pack; see [Changing the Main Battery Pack](#) on paragraph 4.18. When you replace the battery door, press the **Power** button to wake the device. **Pressing the front Scan key will not wake up the device when the battery door is replaced.**

Troubleshooting Suspend/Resume

If the terminal does not wake when you press the Power button, the main battery might be too low to resume operation. To check, remove the battery and install a fully charged battery or connect the terminal to a Handy Terminal charging peripheral.

4.24. Memory Allocation

You can verify file storage and program memory in System Properties.

1. Tap **Start** -> **Settings** -> **Control Panel** -> **System** -> **Memory** tab.



4.25. Care and Cleaning of the Products

When needed, clean the image engine window and the LCD display with a clean, non-abrasive, lint-free cloth. The terminal can be cleaned with a damp cloth.

4.26. PM260 Technical Specifications

Model	PM260
Operating System	Microsoft Windows Embedded CE 6.0 Pro
Development Environment	HT_SDK_Vxxx.msi
Application Software	Tools and Demos
Processor	Marvell® PXA 300 624MHz

Memory	128MB RAM X 128MB Flash
Storage Expansion	User accessible Micro SD memory card slot. Please contact your Toshiba sales representative for available qualified card options.
Display	2.8 in. transmissive active matrix 65K color LCD with backlight, QVGA (240 x 320)
Scan Engine	1D Laser : N4313 2D Imager : IT5300SR
Keypad	29-key shifted alpha numeric
Audio	Built-in microphone and speaker
I/O	Full speed USB 2.0 from cradle (or I/O cable); RS232 (115 Kbps) from cradle
Battery	Standard Li-ion battery 3.7V / 2200 mAh / 8.1 Wh High capacity Li-ion battery 3.7V / 3300 mAh / 12.2 Wh (optional)
Expected Hours of Operation	8+ hours (with scan and continuously transmitting if using new standard Li-ion battery)
Charging	5V input through bottom access
Expected Charge Time	Standard Capacity: 2200mAh – approx. 4 hours Extended Capacity: 3300mAh – approx. 6 hours
Charging Peripherals	AC Adaptor Single Slot Docking cradle–single-bay terminal charge/communicate Single Slot Ethernet cradle–single-bay terminal charge/communication base (Via Ethernet connection)
WPAN	Bluetooth Class II (10 m) v2.0 Enhanced Data Rate (EDR) with on-board antenna.
WLAN	Dual Mode 802.11 b/g/n (11 Mbps/54 Mbps) with internal antenna
WLAN Security	Wi-Fi Certified, 802.1X, WPA2, EAP, WEP, LEAP, TKIP, MSD, EAP-TLS, EAP-TTLS, WPAPSK, PEAP, CCXv4
Operating Temperature	14° to 122°F (-10° to 50°C)
Charging Temperature	37.4° to 107.6°F (3~42°C (±3°C))
Storage Temperature	-4° to 158°F (-20° to 70°C)
Humidity	95% humidity, non-condensing
Construction	High impact resistant PC/ABS housings Magnesium alloy internal chassis with component shock mounts
Drop	6ft(1.8m) multiple drops to concrete, all axis and 2 cycle at room temperature
Tumble	3.3 ft (1.0m) tumbles (1,000 drops)
ESD	Air: ± 15kV Direct: ± 8kV
Environmental	Independently certified to meet IP65 standards for moisture and particle resistance
Dimensions	H; 182mm x W; 66.5mm x D; 30.5mm(grip), 39mm(top)

Weight	1) 1D ; 293g (318g with High capacity battery) 2) 2D ; 288g (313g with High capacity battery)
Scanner / Decode Capabilities	2D Imager model: IT5300SR 2D Imager. Decodes all standard 1D, 2D, Postal, and OCR codes. 1D Laser model: N4313 laser engine. Decodes all standard 1D codes.

5. Using the Keypad

5.1. Numeric Keypad Layout

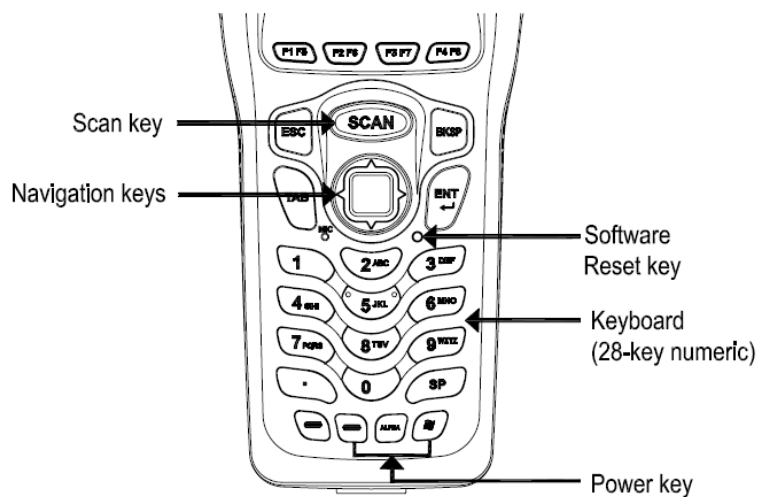

5.2. Navigation Keys

Located in the center of the keypad for easy access with either hand, the navigation keys enable you to move the cursor up and down lines and from character to character.

5.3. Basic Keys

Name	Function
ALPHA	Toggles the keypad between alpha (upper and lowercase) and numeric modes. Indicator changes accordingly on the command bar.
Backspace	Backspace moves the cursor back one space. If you are typing text, a character is deleted each time you press the backspace key.
RED	Modifies the next key pressed to type specific characters.
BLUE	Modifies the next key pressed to type specific functions.
Escape	Cancels an action.
Enter	Performs the same function as the Enter key on a workstation.
BLUE+Start	Suspends and resumes the terminal.

Scan	Activates the image engine to scan a bar code or take an image.
Space	Moves the cursor one space forward. If you are typing text, it moves the text one space forward as well.





5.4. Alpha/Numeric Modes

The keypad defaults to numeric mode. Use the ALPHA key to toggle between numeric and alpha modes.

Pressing the ALPHA key once locks the keypad in numeric mode, alpha mode (lowercase), or alpha mode (uppercase).

The command bar on the screen displays an icon that indicates the alpha/numeric status of the keypad.



Icon	Keypad Status
	Lowercase alpha mode.
	Uppercase alpha mode.
	Numeric mode.
	RED mode
	BLUE mode

5.5. Alpha Indicators on the Numeric Keys

Each number key display the characters typed when you press that key in alpha mode.

Note that when typing in alpha mode, you must use the same multi-press method you would use when typing letters on a phone keypad. Each key press types the next letter in the sequence as displayed by the alpha indicator.

5.6. BLUE Key Combinations

BLUE key modifies the next key pressed to perform specific functions.

Key Combination	Function
BLUE + F1	F5
BLUE + F2	F6
BLUE + F3	F7
BLUE + F4	F8

BLUE + 1	F9
BLUE + 2	F10
BLUE + 3	F11
BLUE + 4	Toggle the wireless radio on and off
BLUE + 5	Increase screen brightness
BLUE + 6	Increase volume
BLUE + 8	Decrease screen brightness
BLUE + 9	Decrease volume
BLUE + 0	Delete
BLUE + SP	Align the screen (Press ESC to exit)
BLUE + Start	Enter suspend mode

The keypad is color-coded in blue to indicate these key combinations.

 **NOTE:** The color-coded indicators are located *upper* each key.

5.7. RED Key Combinations

RED key modifies the next key pressed to type specific characters.

Key Combination	Function
RED + 1	!
RED + 2	@
RED + 3	#
RED + 4	\$
RED + 5	%
RED + 6	^
RED + 7	&
RED + 8	(
RED + 9)
RED + .	- (minus)
RED + 0	*
RED + SP	+ (plus)

The keypad is color-coded in yellow to indicate these key combinations.

 **NOTE:** The color-coded indicators are located *upper* each key.

5.8. Program Buttons

Buttons can be programmed to execute different functions using the Program Button program in the Control Panel. The following buttons on the HANDY TERMINAL are programmed for the listed function. Press and hold BLUE key and press the appropriate function key to execute the indicated function.

Key Combination	Function
F1 ~ F11	Not assigned any function by default

6. Using the Image Engine

6.1. Overview

The HANDY TERMINAL contains an IT5300SR 2D image engine that instantly reads all popular 1D and 2D bar codes and supports omni-directional aiming and decoding or a N4313 1D laser engine that reads all popular 1D bar codes. The image engine can also capture digital images, such as signatures and pictures.

 **NOTE:** It may not read the barcode due to specular reflection if scanning from directly above. Try again after changing angle.

 **NOTE:** It may not read the barcode, if this handy terminal is too close to or too far from the barcode even if the barcode is within the aiming range. Move the handy terminal toward or away from the barcode slowly and try again. The aiming range is for reference only.

 **NOTE:** It may not read the barcode if the barcode surface is curved. Scan the barcode at the center of the aiming range.

 **NOTE:** It may not read the barcode if the barcode surface is dirty. Try again after cleaning the barcode.

 **NOTE:** It may not read the barcode if the image engine window is dirty. Try again after wiping the window with a cotton swab or similar soft object gently.

 **NOTE:** It may not read the barcode according to the direct sunlight or the brightness of the surrounding. Try again away from the direct sunlight. Try again after adjusting the brightness of the surrounding if indoors.

 **NOTE:** It may not read the barcode if it is blue on white background. Try again after changing angle or adjusting the brightness of the surrounding.

 **NOTE:** It may not read the barcode if it is black on silver background. Try again after changing angle or adjusting the brightness of the surrounding.

 **NOTE:** Bar codes printed on glossy or laminated paper are best read at angles greater than 5° in relation to the Laser Engine. This prevents bright illumination reflections from being returned to the Laser Engine..

 **NOTE:** Performance may be impacted by bar code quality and environmental conditions

 **NOTE:** Misreading may occur, if the bar code isn't positioned correctly. Recommended scanner beam positions are as follows

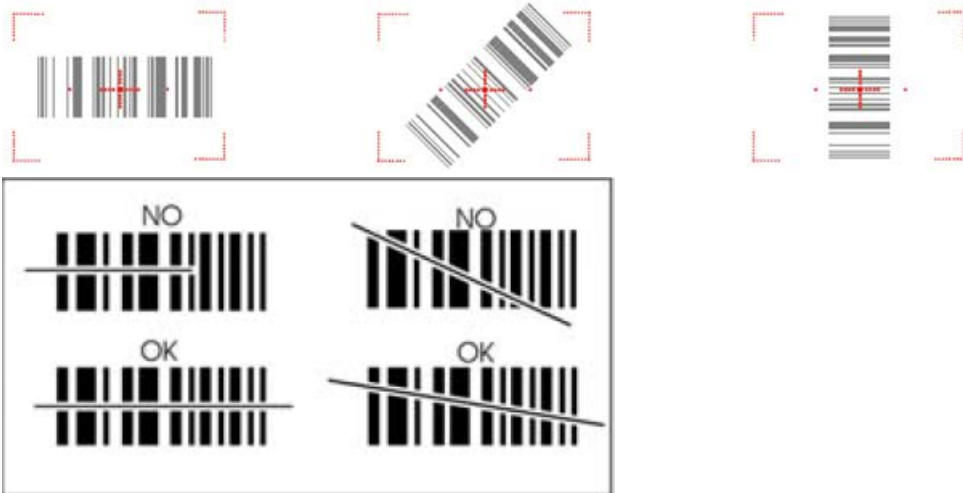

6.2. Available Image Engines

The HANDY TERMINAL is equipped with an IT5300SR

6.3. Depth of Field

Depth of Field for IT5300SR

Code Size	Reference Range	
	Near Distance (in/cm)	Far Distance (in/cm)
MaxiCode 35 mil	2.1in / 5.3cm	12.4in / 31.4cm
Data Matrix 15 mil (ECC200)	2.4in / 6.1cm	9.7in / 24.6cm
PDF417 10 mil (ECL4)	3.2in / 8.1cm	8.6in / 21cm
PDF417 8.3 mil (ECL4)	3.5in / 8.9cm	7.6in / 19.3cm
PDF417 6.6 mil (ECL4)	4.7in / 12cm	5.9in / 15.1cm
Code 39 15 mil	2.2in / 5.6cm	12.2in / 30.9cm
Code 39 10 mil	3.4in / 8.5cm	8.7in / 22.2cm
Code 39 8 mil	3.7in / 9.3cm	7.2in / 18.3cm
UPC 13 mil, 100%	2.2in / 5.6cm	12.2in / 31cm
Postnet	4.2in / 10.7cm	5.6in / 14.2cm
QR Code 15 mil	3.2in / 8.1cm	8.4in / 21.2cm

OCR A, 12 pt	2.4in / 6.1cm	8.9in / 22.7cm
OCR B, 12 Pt	2.6in / 6.7cm	9.5in / 24.1cm

 **NOTE:** Test Condition: Room Temperature (Approx. 20°C), 450 ~ 500 Lux.

6.4. Supported Bar Code Symbologies

Symbology Type	Symbology Name
1D Symbologies	Codabar Code 11 Code 128 Code 39 Code 93 / 93i EAN-8 EAN-13 Interleaved 2 of 5 Reduced Space Symbology UPC-A UPC-E Straight 2 of 5 (IATA) MSI Trioptic Code Code 32 Pharmaceutical (PARAF) Matrix 2 of 5 Plessey Code Telepen GS1-128 ISBT 128 Straight 2 of 5 (Industrial) UPC-A (Coupon Code) UPC-E1
2D Symbologies	Aztec Code Code 49 Data Matrix MaxiCode MicroPDF417 PDF417 QR Code and Micro QR Code Code 16K Label Code 4 & 5 Han Xin Grid Matrix PosiCode
Composite Codes	EAN.UCC Composite Codablock F TCIF Linked Code 39 (TLC39)
OCR	OCR
Postal Codes	Postnet British Post (BPO) Canadian Post Australian Post Japanese Post Planet Code KIX (Netherlands) Post China Post Korea Post 4-CB (4-State Customer Barcode) ID-Tag (UPU 4-State)

6.5. Activating the Engine

When a scanning application is open, press the **Scan** key to activate the image engine.

6.6. Using Demos

Handy Terminal Demos are software utilities loaded on all Handy Terminal terminals that demonstrate the advanced features of the terminal. There are two Demos that feature the image engine: Image Demo and Scan Demo.

To access these demos, tap **Start** -> **Programs** -> **Demos**.

- Select **Scan Demo** to verify decoding, or
- Select **Image Demo** to verify imaging (not available on device using the N4313 laser engine).

6.7. Decoding

The Handy Terminal supports Full-area Imaging decode mode.

Full-area Imaging

With full-area imaging the Handy Terminal supports omni-directional aiming meaning that a positive read can be obtained from many positions. For details, see Omni-Directional Scanning Positions on paragraph 6.10.

6.8. To Decode a Bar Code

1. Tap **Start** -> **Programs** -> **Demos** -> **Scan Demo**.
2. Position the Handy Terminal over one of the Sample Bar Codes on paragraph 6.9.
A range of 4–10 inches (10–25 cm) from the bar code is recommended.
3. Project the aiming brackets by pressing and holding the **Scan** key. The Scan LED lights red.
4. Center the aimer crosshair over the bar code. The aiming beam should be oriented in line with the bar code to achieve optimal decoding; Omni-Directional Scanning Positions on paragraph 6.10.
5. When the bar code is successfully decoded, the decode LED lights green and the terminal beeps.

6.9. Sample Bar Codes

You can use the following bar codes to verify decoding:

Code 39



PDF 417



6.10. Omni-Directional Scanning Positions

The high-vis aiming pattern frames the bar code to provide you with the best scanning performance.

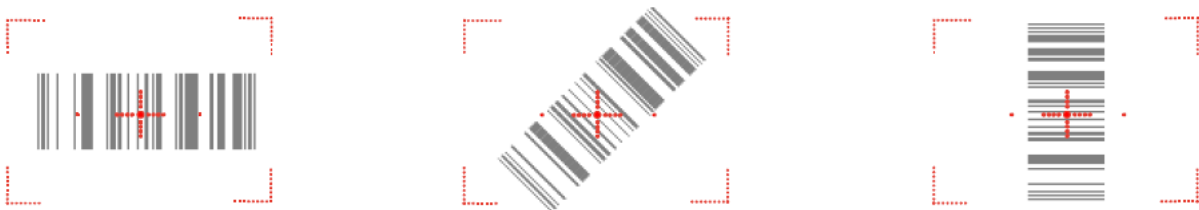

 **NOTE:** To achieve the best read, the aiming beam should be centered horizontally across the bar code.

The aiming pattern is smaller when the terminal is held closer to the code and larger when the terminal is held farther from the code. Symbologies with smaller bars or elements (mil size) should be read closer to the unit whereas larger bars or elements (mil size) should be read farther from the unit.

6.11. Capturing Images (IT5300SR Engine Only)

The image-capture process is an intuitive, split-second operation for experienced users. By following basic guidelines, however, new users can easily develop their own technique and, with practice, quickly learn to adapt to different application environments.

Image Preview

When the imaging process is initiated, the touch screen displays a preview of the object. This is a live video image of what the imager is currently viewing and has a slightly degraded appearance compared to the captured image. This is normal; the captured image has a higher resolution.

File Formats

The Handy Terminal supports BMP file format only.

7. Using the Laser Engine

7.1. Overview

The HANDY TERMINAL (N4313 laser version) contains a laser diode that emits a beam toward an oscillating mirror that scans through the code and the reflected light is bounced off of two mirrors back to the collector. The laser version reads all popular 1D bar codes. See Overview on paragraph 6.1 also.

 **NOTE:** Performance may be impacted by bar code quality and environmental conditions.

7.2. Available Laser Engines

The HANDY TERMINAL can be equipped with an N4313 laser engine (depending on the configuration purchased).

7.3. Depth of Field

Depth of Field for N4313

Code Size	Reference Range	
	Near Distance (in/cm)	Far Distance (in/cm)
Code 39 4 mil	5in / 12.7cm	5.4in / 13.8cm
Code 39 5 mil	4.1in / 11.7cm	7.2in / 18.4cm

Code 39 7.5 mil	4.1in / 10.4cm	10.7in / 27.4cm
Cede 39 10 mil	3.4in / 8.7cm	14.5in / 36.9cm
UPC 13 mil, 100%	1.9in / 4.7cm	16.8in / 42.8cm
Code 39 15 mil	1.9in / 4.7cm	19.9in / 50.4cm
Code 39 20 mil	(*)	25.5in / 64.6cm
Code 39 40 mil	(*)	26.7in / 67.5cm
Code 39 55 mil	(*)	31.8in / 80.8cm

 **NOTE:** Test Condition: Room Temperature (Approx. 20°C), 450 ~ 500 Lux.

 **NOTE:** * = dependent on width of bar code.

7.4. Supported Bar Code Symbologies

Symbology Type	Symbology Name																								
1D Symbologies	<table> <tr> <td>Codabar</td> <td>UPC A</td> </tr> <tr> <td>Code 39</td> <td>UPC E</td> </tr> <tr> <td>Interleaved 2of 5</td> <td>EAN 13</td> </tr> <tr> <td>Nec 2of5</td> <td>EAN 8</td> </tr> <tr> <td>Code 93</td> <td>MSI</td> </tr> <tr> <td>Straight 2of5 Industrial</td> <td>Plessey</td> </tr> <tr> <td>Straight 2 of 5 IATA</td> <td>GS1 Databar Omnidirectional</td> </tr> <tr> <td>Matrix 2 of 5</td> <td>GS1 Databar Limited)</td> </tr> <tr> <td>Code 11</td> <td>GS1 Databar (Expanded</td> </tr> <tr> <td>Code 128</td> <td>China Post</td> </tr> <tr> <td>GS1 128</td> <td>Trioptic</td> </tr> <tr> <td>Telepen</td> <td></td> </tr> </table>	Codabar	UPC A	Code 39	UPC E	Interleaved 2of 5	EAN 13	Nec 2of5	EAN 8	Code 93	MSI	Straight 2of5 Industrial	Plessey	Straight 2 of 5 IATA	GS1 Databar Omnidirectional	Matrix 2 of 5	GS1 Databar Limited)	Code 11	GS1 Databar (Expanded	Code 128	China Post	GS1 128	Trioptic	Telepen	
Codabar	UPC A																								
Code 39	UPC E																								
Interleaved 2of 5	EAN 13																								
Nec 2of5	EAN 8																								
Code 93	MSI																								
Straight 2of5 Industrial	Plessey																								
Straight 2 of 5 IATA	GS1 Databar Omnidirectional																								
Matrix 2 of 5	GS1 Databar Limited)																								
Code 11	GS1 Databar (Expanded																								
Code 128	China Post																								
GS1 128	Trioptic																								
Telepen																									

7.5. Activating the Engine

When a scanning application is open, press the Scan key to activate the laser engine.

7.6. Using Demos

Handy Terminal Demos are software utilities loaded on Handy Terminals that demonstrate the advanced features of the terminal.

To access these demos, tap **Start > Programs > Demos**.

- Select **Scan Demo** to verify decoding

7.7. Decoding a Bar Code

1. Tap **Start > Demos > Scan Demo**.

2. Position the Handy Terminal over one of the Sample Bar Codes on paragraph 7.8. A range of 4-10 inches (10-25 cm) from the bar code is recommended.
3. Project the aiming beam by pressing and holding the **Scan** key. The Scan LED lights red.
4. Center the aimer beam horizontally over the bar code and highlight all of the vertical bars of the bar code. The aiming pattern is smaller when the terminal is held closer to the code and larger when the terminal is held farther from the code. Symbologies with smaller bars or elements (mil size) should be read closer to the unit whereas larger bars or elements (mil size) should be read farther from the unit.
5. When the bar code is successfully decoded, the decode LED lights green and the terminal beeps.

7.8. Sample Bar Code

You can use the following bar code to verify decoding:



7.9. Scanning Positions

The aiming beam must be aimed across the entire bar code to provide you with the best scanning performance. The aiming pattern is smaller when the terminal is held closer to the code and larger when the terminal is held farther from the code. Symbologies with smaller bars or elements (mil size) should be read closer to the unit whereas larger bars or elements (mil size) should be read farther from the unit.



8. Using ScanWedge

8.1. Overview

ScanWedge sends data from the installed scan engine(N4313 or IT5300SR) to the foreground application as keystrokes or clipboard. The foreground application is the open software application whose window is currently active on the display.

As a result, you can check decoded bar code data with Microsoft WordPad.

8.2. Enabling ScanWedge

ScanWedge is enabled by default in Handy Terminal

Tap the ScanWedge icon **once** . ScanWedge initializes and enables.

Command Bar Menu

Tap  icon in taskbar to open the command bar menu.

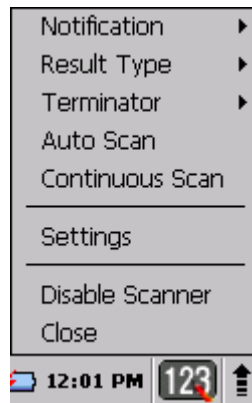

Menu Item	Sub Item	This item ...
Notification	Beep	Enables and disables the audio notification for decode/data reception. There is one sound for success and another sound for an error.
	LED	Enables and disables LED notification for decode/data reception.
	Vibrator	Enables and disables Vibrator notification for decode/data reception.
		Specifies the method to use when sending the decoded message to the foreground application
Result Type	Keyboard Event	Send decoded bar code data as Keyboard event(stroke)
	Clipboard	Send decoded bar code data to clipboard(copy & paste)
Terminator	None	Add nothing at end of decoded bar code data
	CRLF	Add CRLF at end of decoded bar code data
	Space	Add Space at end of decoded bar code data
	Tab	Add Tab at end of decoded bar code data
Auto Scan	-	Enable Auto Scan feature
Continuous Scan	-	Enable Continuous Scan feature
Setting	-	Open Scanner setting applet
Disable Scanner	-	Disable Scanner trigger
Close	-	Close Scanwedge

9. Using Control Panel

9.1. System Properties



System

Refer to the System control panel for information related to the system.

9.2. General



1. Select
2. Start > Settings > Control Panel > System Properties > General tab to determine the following information about your PDA:

- Operating system
- Processor
- Memory
- Expansion cards

9.3. Memory

Specifies available ROM and RAM capacity



9.4. Device name

Your device uses this information to identify itself to other computers.

Terminal Serial Number will be in Device Name section by default. You can modify it



9.5. Copyrights

9.6. Power properties



Power

9.7. Battery tab

To see main and backup battery level indicators open

Start > Settings > Control panel > Battery or double tap on **Battery** icon in taskbar.

The option to enable/disable the backup battery charging from the main battery



9.8. Power off tab

To adjust power management settings,

1. Select
Start > Settings > Control Panel > Power off.
2. Set idle time when on battery power before device suspends.
3. Set idle time when on external power before device suspends.
4. To exit, press **OK** from the command bar, or press the < **ENT** > key on the keypad.

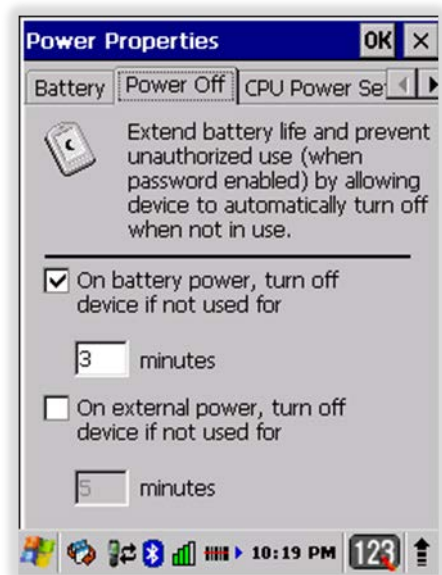

NOTE: To save battery life it is recommended to set idle time as short as possible.

9.9. CPU Power Setting Tab

Handy Terminal has DFM(Dynamic Frequency Management) and DVM(Dynamic Voltage Management) to extend battery life time.

It has Auto, 104MHz, 416MHz and 624MHz mode.

According to CPU time needed by application, Handy Terminal raises the power mode from 104MHz to 624MHz and steps down from 624MHz to 104MHz operating point. If you set minimum operation point to 416MHz, this means CPU runs at only 416MHz or 624MHz frequency.

Handy Terminal automatically sets the minimum operation to 624MHz when AC power attached and Scan button is pressed and releases it when AC power detached and Scan button is released.



9.10. Alerts Tab

Adjust the level of main battery for Low battery message and Critical battery message.

By default, 20% is set for Low battery message and 10% is set for Critical battery message

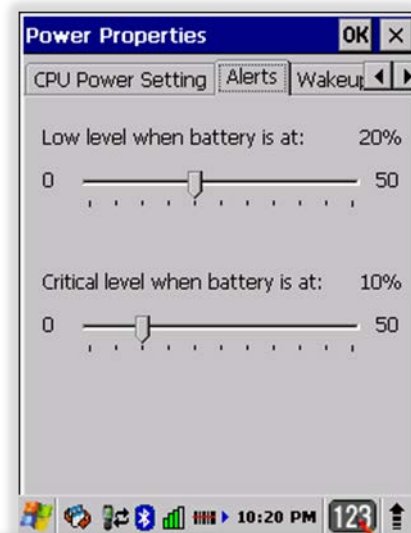

9.11. Wakeup Source Tab

Enable Wake(Resume) resources from suspend(Sleep) mode

By default, all available resources are enabled.

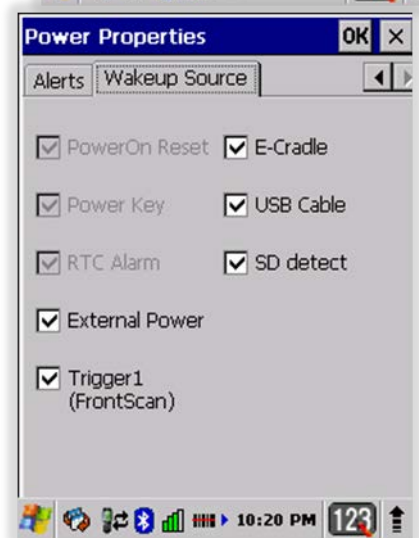

9.12. Program Button properties



Program Buttons

9.13. Program Buttons Tab

1. Select
Start > Settings > Control Panel > Program buttons
2. Chose its type:
 - **Default** – button will be assigned default function.
 - **No function** – button does not have any functions.
 - **Scan key** – button is used as Scan key.
 - **Application** – click on **Open** button and select application to bind with this key.
4. To exit, press **OK** from the command bar, or press the < **ENT** > key on the keypad

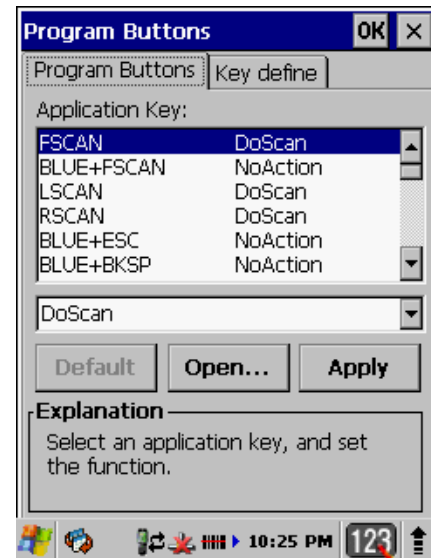

9.14. Key define Tab

1. Select
Start > Settings > Control Panel > Program buttons > Key define tab
2. Current key definition file
Basic file is set in the windows folder.
3. Chose its type:
 - **Open** – button is used to assign new key definition file to [Setting new key define file] edit box.
 - **Apply** – button is used to apply [Setting new key define file] to the system.
 - **Default key definition file** – button is used to assign basic definition file back.
To apply this setting, Click on **Apply** button.
4. To exit, press **OK** from the command bar, or press the < **ENT** > key on the keypad

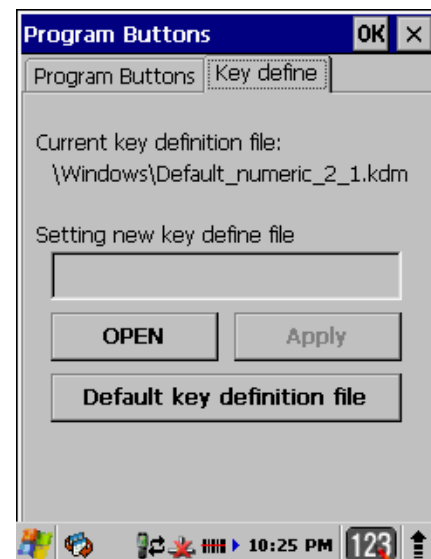

 **NOTE:** It is useful for a customer to want to remap keyboard.

9.15. Backlight Properties



Backlight

Modify display and keyboard backlight brightness. Also set backlight options (i.e. turn off time).

To modify backlight settings open:

Start > Settings > Control Panel > Backlight

9.16. Battery power Tab

Modify display backlight settings when device runs on batteries.

- Set display brightness level
- Set backlight timeout time.

Available options:

10 sec

30 sec (*by default*)

1 min

2 min

3 min

4 min

5 min

- Enable to turn on backlight when a button is pressed or the screen is tapped

NOTE: To extend battery life it is recommended to set display backlight turn off time as short as possible.

NOTE: To extend battery life it is recommended to set display backlight brightness level as low as possible.

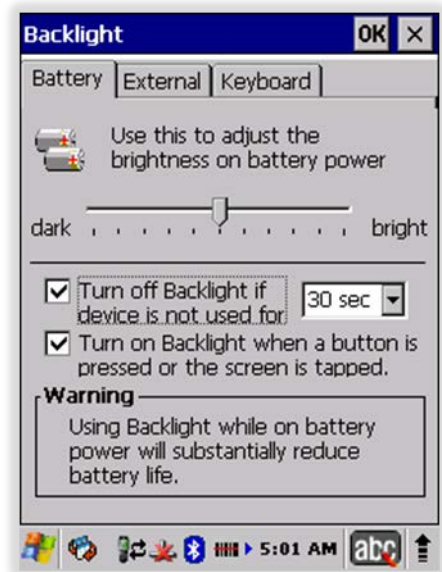

9.17. External power Tab

Modify display backlight settings when device runs on external power.

- Set display brightness level
- Set backlight timeout time.

Available options:

Unchecked (*By default*)

1 min

2 min

5 min

10 min

15 min

30 min

- Enable to turn on backlight when a button is pressed or the screen is tapped



9.18. Keyboard backlight Tab

Enable Keyboard backlight when button is pressed

By default this is turned off.



9.19. Scanner Settings



Scanner Settings

To change the Scanner configuration parameter as follows:

Tap the Scanwedge icon in the System Tray to open the menu shown in image on the right and select **Settings** to open the Scanner Settings applet or Start > Settings > Control Panel > Scanner Settings

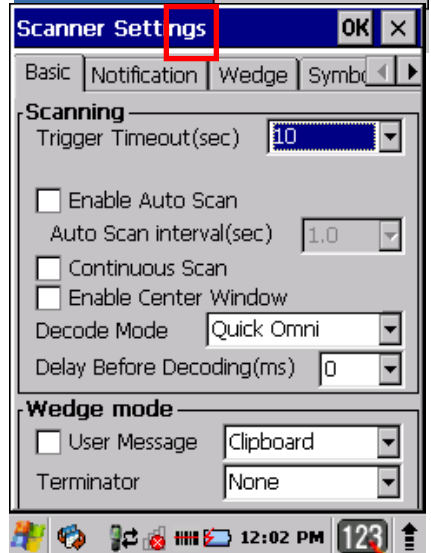

9.20. Scanner Settings Applet

Tab	Section	Option	Description
-----	---------	--------	-------------

Basic	Scanning	Trigger timeout (sec)	Specifies the trigger time out in seconds. If a barcode is not decoded within the specified timeout, the default Notifier indicates that decoding is failed
		Enable Auto Scan	Enable Auto Scan with specified interval.
		Auto Scan interval (sec)	Set Auto Scan interval time.
		Continuous Scan	Enable Continuous Scan without any interval.
		Enable Center Window(IT5300SR device only)	Enable Center window. Bar codes are decoded only if they are within the specified windows
		Decode Mode(IT5300SR device only)	Standard: Quick Omni <i>(By default)</i> :
		Delay Before Decoding(IT5300SR device only)	Start to decoding after specified milliseconds Values: 0(default), 100, 200, 300, 400, 500, 600, 700, 800, 900, 1000
	Wedge mode	User Message	Select Result Type User Message Keyboard Event Clipboard(default)
		Terminator	Select the desired barcode end method from the pull down list. Values: None, CRLF, Space, Tab
	Power Save Options (N4313 device only)	Power Save Mode	Select Power Save Mode OFF SLEEP HIBERNATE(default)
Power Save TimeOut (sec)		1~65535	
Notification	Beep If enabled – plays audio sound	Volume	Set sounds volume.
		Good read	Set sound to indicate good read.
		Bad read	Set sound to indicate bad read.
	LED	Enable	Enable visual scan indicators.
	Vibrator If enabled - Turn on LED for good/bad scan indicator	Good read	Set vibration time after good read.
Bad read		Set vibration time after bad read.	
Wedge	Barcode ID	Transmit Barcode ID	Enable to transmit predefined barcode ID in Detail tab
	Label	Prefix	Enter Prefix to be sent prior to the decoded/received data.

		Suffix	Enter Suffix to be sent after the decoded/received data
Symbologies	Select barcode types you want to read There is "Enable All" and "Disable All" to enable/disable all symbologies		

Tab	Section	Option	Description
Details	Specifies or enable available detail settings in symbologies	Enable this code	Tap/enable this checkbox to enable the selected bar code type.
		Barcode ID	Enter the desired features you wish to transmit as bar code ID
		Length	Set the minimum and maximum lengths from the pull-down lists. If the numbers are the same, acceptable bar codes will only be that length. Not all types will have this option enabled.
		Redundancy(N4313 device only)	If you are encountering errors when reading some bar codes, you may want to adjust the redundancy count. Redundancy adjusts the number of times a bar code is decoded before transmission, which may reduce the number of errors. Note that the higher the redundancy count, the longer it will take to decode the bar code
About	Specifies Barcode engine type, Firmware revision, Decider revision, API revision		
	Load Factory Default	After modifying the current settings, if you wish to return to the factory defaults, tap the Load Factory Default button.	

10. Communication

10.1. *Communication Options*

Handy Terminal offers several communication options including Microsoft ActiveSync and wireless radios.

I/O Connector (Wired Communication)

The mechanical connector on the bottom panel connects the terminal to various Handy Terminal communication peripherals that connect to a host workstation via USB (1.1 or higher), thus enabling ActiveSync communication.

For more information, see ActiveSync Communication on paragraph 10.4.

Wireless Radios (Wireless Communication)

HANDY TERMINALS can be equipped with an 802.11b/g/n and Bluetooth radio.

For more information, see Wireless Radios on paragraph 10.14.

10.2. *Installing Additional Software*

Handy Terminal is shipped with the operating system, radio drivers, and custom software (CICO) already installed. These are the default programs that install when your terminal first boots up. You can install additional software programs on the terminal provided that the following parameters are met:

- The software program was created for a Windows CE device.
- The terminal has enough memory to store and run the program.
- The program has an EXE, CAB, or DLL extension.

When selecting programs, verify that the program and version of the program are designed for the Windows Embedded CE 6.0 Pro and the terminal's processor. You can verify your processor by tapping **Start** -> **Settings** -> **Control Panel** -> **System** -> **General** tab. Make a note of the information in the **Processor** field.

To install additional software, you can use the communication options described in this chapter.

- [Adding Programs via ActiveSync](#) (paragraph 10.13).
- [Adding Programs from the Internet](#) (paragraph 10.17).

10.3. *Connecting the USB ActiveSync Cable*

To facilitate USB communication between the Handy Terminal and the host workstation, you may connect your unit to a host by using either the USB ActiveSync cable, the optional Single Slot Docking Cradle or the optional Single Slot Ethernet Cradle. If you use the Communication Cable, slide the cable unit onto the bottom of the terminal lining up the terminal's I/O connector with the cable unit's connector.

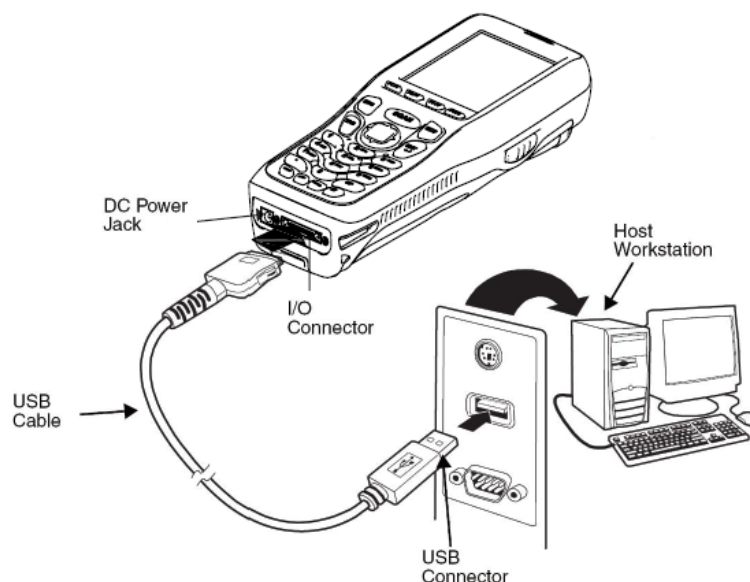

10.4. *ActiveSync Communication*

To synchronize, ActiveSync 4.1 or higher must be installed and configured for the appropriate communication type on the host workstation and the Handy Terminal. Handy Terminals ship with ActiveSync already installed. Therefore, if ActiveSync is already installed on the host workstation, you just need to connect the Handy Terminal to the host workstation (via Handy Terminal peripheral) to initiate communication.

 **NOTE:** You can download the most current version of ActiveSync (for Windows XP) or Windows Mobile Device Center (Windows Vista, 7) from www.microsoft.com.

 **WARNING:** When communicating via ActiveSync, your terminal is designed to be connected to the host workstation with a Toshiba_Tec communication peripheral. We recommend use of Pointmobile peripherals, power cables, and power adapters. Use of any non-Pointmobile peripherals, cables, or power adapters may cause damage not covered by the warranty.

10.5. *Communication Type*

The HANDY TERMINAL supports the following type of communication via ActiveSync through its I/O connector on the bottom panel:

USB The USB cable and hardware peripherals allow the Handy Terminal to communicate with a workstation through a USB port or to a network through a USB hub. The Handy Terminal supports full-speed USB communication (USB 2.0); maximum data transfer rate is 12 Mbps. The Handy Terminal defaults to USB communication out of the box.

10.6. *Hardware Requirements for Setup*

- AC Adaptor (if needed)
- USB ActiveSync Cable (for USB communication)
- ActiveSync v4.1 or higher (for Windows XP), Windows Mobile Device Center (for Vista and Windows 7) installed on the host workstation
- Windows XP, Windows Vista, Windows 7 computer.

10.7. *Software Requirements for Communication*

To sync successfully, ActiveSync must be configured for the same communication type on both the host workstation and the Handy Terminal. ActiveSync must be setup on your workstation before you initiate synchronization from the terminal for the first time.

10.8. *Setting Up the Host Workstation*

Verify that ActiveSync is configured to use the appropriate communication type by selecting **File -> Connection Settings**.

For USB communication, check **Allow USB connections**.

10.9. *Setting Up the Handy Terminal*

The Handy Terminal defaults to USB communication out of the box. To verify and/or change the default setting, tap **Start -> Settings -> Control Panel -> PC Connection**.

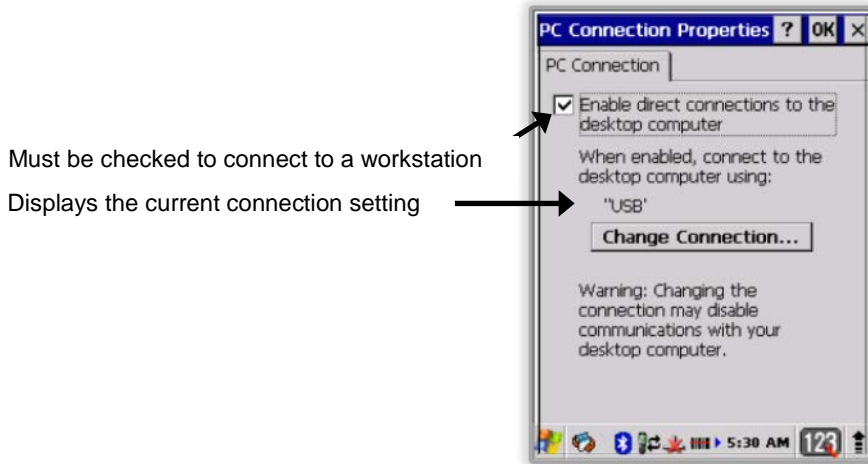

10.10. *Communicating with the Handy Terminal*

After setting up both the workstation and the terminal, ActiveSync connection should be automatic.

1. Connect the Handy Terminal to a communication peripheral, such as the Handy Terminal Docking cradle.
2. The Handy Terminal automatically opens ActiveSync or Windows Mobile Device Center to establish a connection.

10.11. *Synchronizing with the Host Workstation*

After setup, synchronization begins automatically whenever the terminal's mechanical connector connects to a Handy Terminal peripheral that is connected to a host workstation with ActiveSync installed.

10.12. *Exploring the Terminal from the Workstation*

When the terminal and desktop computer are connected, open the main ActiveSync window (on the desktop), and click **Explore**.

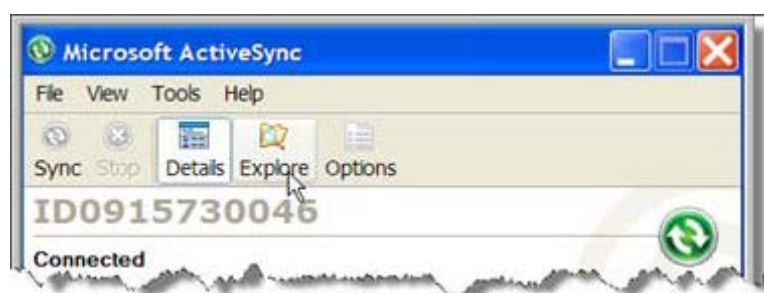

The Mobile Device folder opens in Windows Explorer.

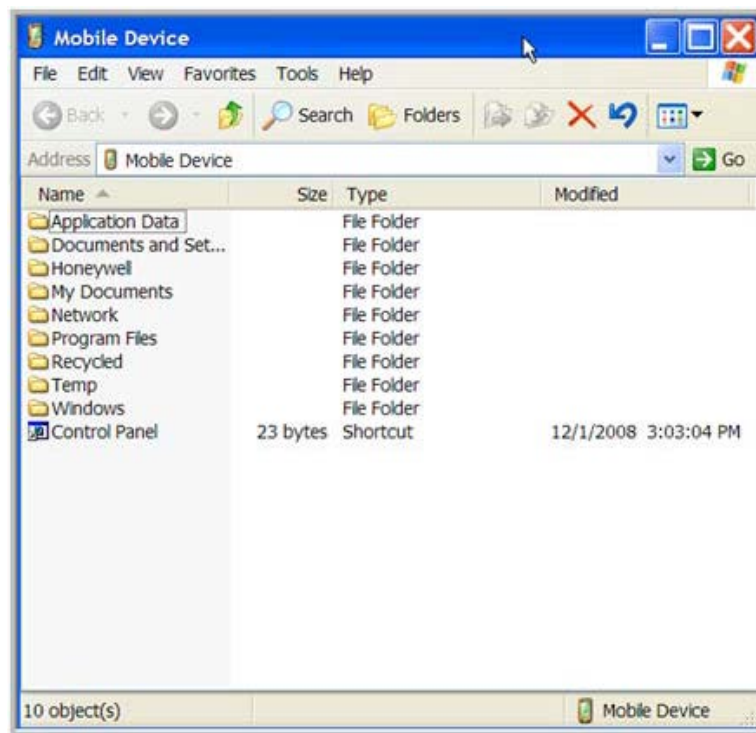

The Handy Terminal is now treated as a mass storage device, and transferring files is as simple as dragging and dropping or copying and pasting as you would for moving files between folders on your hard drive.

10.13. Adding Programs via ActiveSync

 **WARNING:** When selecting programs, verify that the program and version of the program are designed for the Windows CE 6.0 Pro and the terminal's processor. You can verify your processor by tapping **Start -> Settings -> Control Panel -> System -> General** tab. Make a note of the information in the Processor field.

Generally, software for Windows CE devices must be installed to the host workstation first, then transferred to the Handy Terminal.

1. Download the program to the workstation from either the Internet or the install CD. You may see a single *.exe or setup.exe file, a *.cab file, or *.dll. (There may also be several versions of files for different device types and processors.)
2. Read any installation instructions, Read Me files, or documentation that comes with the program. Many programs provide special installation instructions.
3. Connect the terminal to the workstation via a Handy Terminal communication peripheral.

If the File is an Installer

An installer program is one that installs to the workstation and the terminal simultaneously; one process installs to both devices.

1. On the workstation, double-click the *.exe or *.setup.exe file. The installation wizard begins.
2. Follow the directions on the workstation screen.
The installation process includes transferring the software to the terminal via ActiveSync.

If the File is Not an Installer

Some programs cannot be installed on workstations because they are designed exclusively for Windows CE devices. In these cases, the appropriate files must be stored on the host workstation and transferred to the terminal via ActiveSync Explore.

 **NOTE:** *If an error message stating that the program is valid but designed for a different type of computer appears when you try to install the program on the workstation, the program is not an installer.*

1. If you cannot find any installation instructions for the program in the Read Me file or documentation, open **ActiveSync** or **Windows Mobile Device Center** on the workstation and click **Explore**.
2. On the workstation, navigate to the workstation folder containing the program file(s) and copy them to the **Program Files** folder on the terminal.
If you want the program to persist through hard resets, save the program to the **Autoinstall \ Cabfile** folder (**AutoInstall\Cabfile**).
3. On the terminal Desktop, tap **My Device** and, in Windows Explorer, navigate to the folder where the program is located.
4. Double tap on the program file to install it.
If you copied the file to the **Autoinstall\Cabfile** folder, you can choose to install the program by performing a hard reset. The program installs as part of initialization.
5. After installation is complete, access the program by tapping **Start** -> **Programs**, and the program appears on the Programs screen. Tap the icon to open the program.

10.14. *Wireless Radios*

There are two radio options: 802.11b/g/n and Bluetooth.

1. **802.11b/g/n** (WPAN/WLAN configuration): see WLAN (802.11b/g/n Radio), below.
2. **Bluetooth** (WPAN configuration): see Bluetooth Handler on paragraph 11.

 **NOTE:** *PM260 does not provide all Bluetooth profiles.*

10.15. *Connecting the Terminal to a Wireless Network*

You connect the terminal to a wireless network through the on-board radio (802.11b/g/n and/or Bluetooth).

Each radio has its own configuration program and requires specific information about the wireless network to connect. Successful connection depends on your network infrastructure about which you will need specific information from your network administrator.

 **NOTE:** *802.11 b/g/n radio module is off by default, in order to avoid wasting energy, you can switch it off using the Wireless Communications applet*

 **NOTE:** *Suspending the terminal powers off the 802.11 b/g/n radio and drops the radio connection. When the*

terminal resumes, depending on the radio power mode and security protocol selected, it may take up to 30 seconds for the 802.11 b/g/n radio driver to re-associate the radio to the network.

 **NOTE:** Area coverage and radio performance may vary, due to environmental conditions, access points types or interference caused by other devices (microwave ovens, radio transmitters, etc.). If necessary, please turn off the WLAN or Bluetooth.

 **NOTE:** Radio performance may vary if using WLAN and Bluetooth simultaneously. If necessary, please turn off either WLAN or Bluetooth.

10.16. *WLAN (802.11b/g/n Radio)*

HANDY TERMINAL has a 2.4 GHz 802.11b/g/n WLAN (Wireless Local Area Network) radio that uses Direct Sequence Spread Spectrum (DSSS) technology. The radio is interoperable with other 802.11b/g/n, Wi-Fi compliant products including access points (APs), workstations via PC card adapters, and other wireless portable devices.

By default, the 802.11b/g/n radio is powered-off (i.e., disabled) “out of the box” To power it on (i.e., enable), press the vertical arrow (bottom right corner of screen) and select **Turn Wireless LAN On**. The enable/disable state of the radio will survive subsequent soft and hard resets. The next step is to configure the connection parameters of the radio to connect to a wireless network.

Configuring the WLAN Radio

The WLAN radio is configured in the Summit Client Utility, which you access by double tapping the program icon in the command bar.

For complete configuration instructions, download the **Summit SCU User’s Guide** from <http://www.summitdata.com/documentation.html>.

10.17. *Adding Programs from the Internet*

When you have established a network connection (whether via Wireless LAN, Bluetooth, or activeSync), you can access the Internet and download additional software programs.

When selecting programs, verify that the program and version of the program are designed for Windows CE 6.0 Pro and the terminal’s processor. You can verify your processor by tapping Start -> Settings -> Control Panel -> System -> General tab. Make a note of the information in the Processor field.

1. Open Internet Explorer and navigate to the program’s location. You may see a single *.exe or setup.exe file, or several versions of files for different device types and processors.
2. Select the program version that matches your Handy Terminal and processor.
3. Read any installation instructions, Read Me files, or documentation that comes with the program. Many programs provide special installation instructions.
4. Download the program to the terminal directly from the Internet.
You would normally store the program in the **Program Files** folder unless another location is required by the program.
5. On the terminal, double tap the installer file; e.g., the *.exe file.
6. The installation wizard for the program begins.

7. Follow the directions on the screen to complete installation.

11. Bluetooth Handler

Bluetooth wireless technology is a short-range communications technology to connect portable and/or fixed devices while maintaining high levels of security.

11.1. *Enabling the Bluetooth Radio*

1. Select the device panel indicated by the **UP** arrow in the lower, right portion of the display.
2. Tap **Turn Bluetooth On**.

The Bluetooth icon appears in the task bar.

 **NOTE:** In order to avoid wasting energy, the Bluetooth module is off by default. If you need to have Bluetooth working, the module must be powered on using the Wireless Communications applet.

 **NOTE:** Suspending the terminal powers off the Bluetooth radio and drops the Bluetooth connection. When the terminal resumes, it takes approximately 10 seconds for the Bluetooth radio driver to re-initialize the radio.

 **NOTE:** Area coverage and Bluetooth radio performance may vary, due to environmental conditions or interference caused by other devices (microwave ovens, radio transmitters, etc.).

11.2. *Connecting to Other Devices*

Before connecting to another device, make sure that the Bluetooth connection on the other device is enabled.

1. Double tap on the Bluetooth icon in the task bar.

The Bluetooth Handler appears on the screen.

2. Tap **Scan Device**.

The available services of all devices / profiles in range display in the Bluetooth Handler.

11.3. *Pairing Bluetooth Devices*

Connecting Bluetooth devices usually requires that they be paired; the same passkey must be entered for each device. If you want to connect the HANDY TERMINAL to a device without any input method (e.g., printers, headsets), refer to the user documentation that accompanied the device for pairing information.

1. Tap on the desired device / profile in the Bluetooth Handler.
2. Select **Trusted** from the drop down menu.

Once asked if you need to authenticate the device,

3. Tap on the **Yes** button.
4. Enter 4 random digits and tap **Yes**.
5. Enter the same digits on the other device when prompted.
6. After pairing, double tap on the selected device / profile and select **Active**.

11.4. *Setting Up a Bluetooth Printer*

1. Make sure that the Bluetooth printer is on and activated.
2. If not done so already, turn Bluetooth On (by selecting the vertical arrow on the Command Bar).
3. Tap **Serial** tab.
4. Tap **Scan Device**, which runs a Bluetooth Inquiry, then SDP Query.
5. If you see your Bluetooth printer device displayed, you can tap **Cancel** to stop the search.

12. Single Slot Docking cradle/Single Slot Ethernet cradle Device

12.1. *Overview*

 **NOTE:** *The information in this chapter applies to both the Single Slot Docking cradle and Single Slot Ethernet cradle devices unless otherwise indicated.*

As the hub of your HANDY TERMINAL system, the Single Slot Docking cradle charging and communication cradle supports full-speed USB 2.0 and RS-232 communication with a workstation. The Single Slot Ethernet cradle is identical to the Single Slot Docking cradle except it supports Ethernet communication as well as full-speed USB 2.0 and RS-232.

12.2. *Battery Charging*

The base completes a full charge of the main battery pack in four hours for the standard capacity 2200mAh pack and six hours for the extended capacity 3300mAh pack on the handy terminal.

The charging time for spare battery on the cradle is four hours thirty minutes for the standard capacity 2200mAh pack and six hours thirty minutes for the extended capacity 3300mAh pack.

In addition to charging, the base powers the terminal's intelligent battery charging system, which protects the battery from being damaged by overcharging. The terminal senses when a battery pack is fully charged and automatically turns off the charger. If the battery voltage drops below the charge threshold, the charger turns on again to maintain the battery at full capacity. As a result, Handy Terminals may be stored in the base indefinitely without damage to the terminals, battery packs, or peripherals. For prolonged storage, see Storage Guidelines on paragraph 4.20. The base can also charge a second battery while the terminal is positioned in the base. See Charging a Spare Battery on paragraph 12.9.

12.3. *Power Supply*

The power cable that ships with each terminal also powers the base.

 **WARNING:** *We recommend use of Pointmobile peripherals, power cables, and power adapters. Use of any non-Pointmobile peripherals, cables, or power adapters may cause damage not covered by the warranty. We recommend use of Pointmobile Li-Ion battery packs. Use of any non-Toshiba battery may damage not covered*

by warranty.



WARNING: DO NOT attempt to charge damp/wet handy terminals or batteries. All components must be dry before connecting to an external power source.

12.4. Front Panel

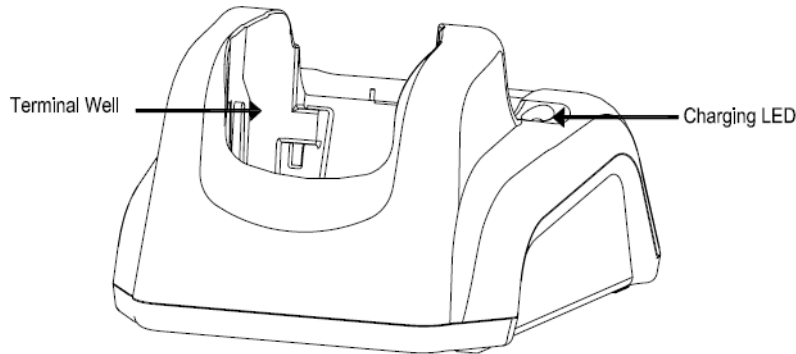

Terminal Well

Place the Handy Terminal in the terminal well to communicate with a host device, power the terminal, and charge the terminal's battery. Make sure that the device is securely seated.

Rubber Feet

The bottom panel has four rubber feet to stabilize the unit on a flat surface. You can set the base on a dry, stable surface, such as a desktop or workbench near an electrical outlet.

12.5. Back Panel

Single Slot Docking Cradle

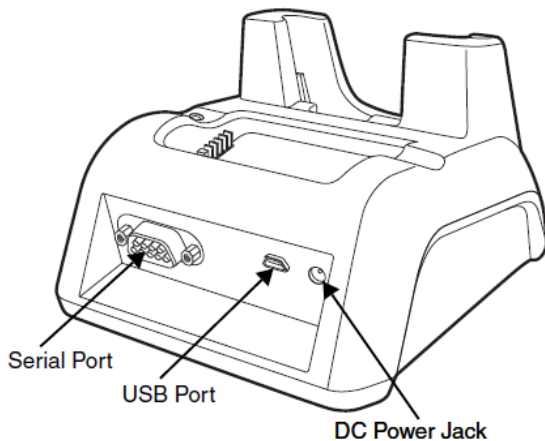

Single Slot Ethernet Cradle

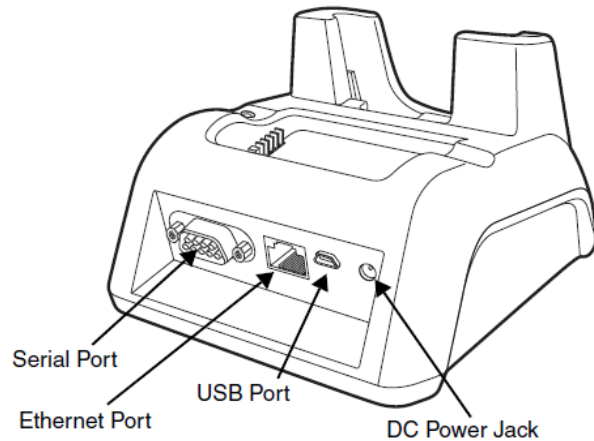

DC Power Jack

Connect the power cable to this power jack; see Powering the Docking cradle Device on paragraph 12.6.

USB Port

The USB port is full-speed (v2.0). Using the USB cable, you can connect the base to a USB-

compliant device to facilitate USB communication to and from the terminal. USB communication occurs through Microsoft ActiveSync (v.4.1 or higher). For more information about ActiveSync setup, see ActiveSync Communication on paragraph 10.4.

Serial Port

The serial port supports serial communication between the terminal and another device. Note that the connector is a DB9 Male connector, requiring a female connector on the serial cable.

The following four signals are supported:

- Transmitted Data
- Received Data
- Request to Send
- Clear to Send

 **NOTE:** *ActiveSync is not supported over the serial port.*

Ethernet Port (Single Slot Ethernet cradle only)

Using an Ethernet cable, you can connect the Single Slot Ethernet cradle to an Ethernet-compliant device to facilitate Ethernet communication to and from the terminal. This equipment is for indoor use only. The communication wiring is limited to the inside of a building.

12.6. *Powering the Single Slot Docking Cradle or Single Slot Ethernet Cradle Device*

The terminal requires DC 5V input for communication and battery charging; the power adapter on the power cable converts the voltage from the power source to DC 5V. Only power adapter cables from Pointmobile convert the voltage appropriately.

The same power cable that ships with each terminal can be used to power the base. This cable contains a plug adapter for each geography (US, UK, EU, etc.).

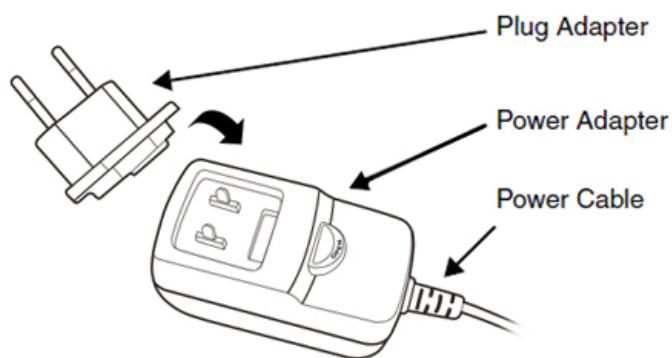

1. Attach the appropriate plug adapter to the power adapter.
2. Plug the power cable into the power source.
3. Plug the connector into the DC power jack on the back panel. The base is now powered.

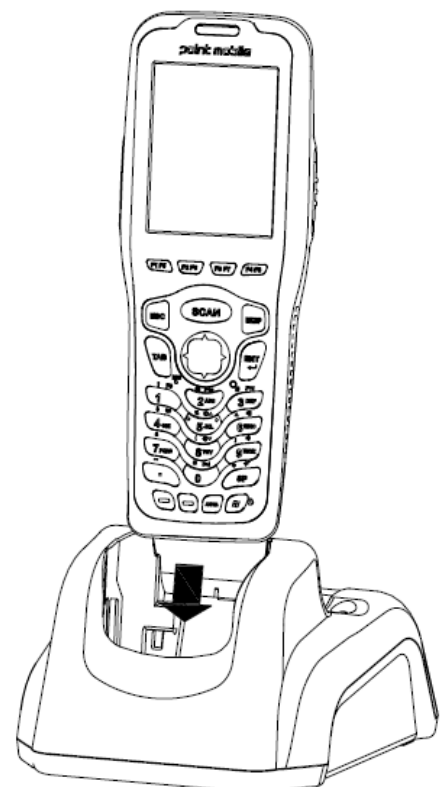

When a terminal is properly seated, the base powers the terminal, charges the terminal's main battery pack, and launches ActiveSync (see ActiveSync Communication on paragraph 10.4).

Pointmobile recommends that you leave the base connected to its power source at all times, so that it is always ready to use.

12.7. *Charging the Main Battery*

The base powers the terminal and fully charges its main battery pack in 4 or 6 hours depending on the battery.

As battery packs charge, the charging circuitry follows the two-step charging process (CC-CV) that is recommended for Li-Ion batteries.

The process monitors changes in temperature, current, and voltage.

 **WARNING:** Do not short-circuit between each contact of the cradle. It may cause fire.

12.8. *Inserting a Terminal*

1. Install the battery pack in the terminal.
2. Power the base; see Powering the Docking cradle Device on paragraph 12.6.
3. Slide the terminal into the terminal well making certain that the terminal is seated properly.
4. The battery pack begins charging.

 **NOTE:** Please hold the cradle with your one hand when removing the terminal from the cradle.

 **WARNING:** Ensure all components are dry prior to mating terminals/ batteries with peripheral devices. Mating wet components may cause damage not covered by the warranty.

12.9. *Charging a Spare Battery*

The base can also charge a second battery while the terminal is positioned in the base. The second battery can be inserted in the battery charging well in back of the terminal connection. Angle the battery as shown. Once the connectors engage, the LED lights. If the LED is red, the unit is charging; if it is green, the charge is complete.

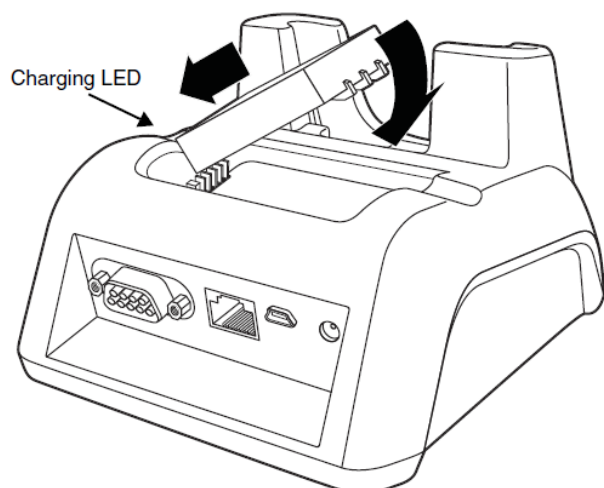

12.10. Charging Backup Battery

To check battery power while the terminal is operating, tap **Start** -> **Settings** -> **Control Panel** -> double tap **Power**.



12.11. Technical Specifications

Model	260-HB (Single Slot Docking Cradle) 260-EHB (Single Slot Ethernet Cradle)
Structural	
Dimensions	135.7mm(D) x 116.4mm(W) x 81mm(H)
Weight	Single Slot Docking cradle - 310g Single Slot Ethernet cradle - 320g
Material	Polycarbonate
Color	Black
Environmental	
Operating Temperature	14° to 122°F (-10° to 50°C)
Storage Temperature	-4° to 158°F (-20° to +70°C)
Charging Temperature	37.4° to 107.6°F (3~42°C (±3°C))
Electrical Static Discharge	Air: ± 15kV Direct: ± 8kV

Humidity	90% relative humidity (non-condensing)
Power Supply	
Input (Universal) (from the power source)	AC 100–240 V, 0.4 A 50/60Hz Included with Handy Terminal
Output (to the cradle)	DC 5V , 2.0 A
Charging	
Standard Charge	Main battery Standard Capacity: 2200mAh – Approx. 4 hours High Capacity: 3300mAh – Approx. 6 hours Spare battery Standard Capacity: 2200mAh – Approx. 4.5 hours High Capacity: 3300mAh – Approx. 6.5 hours
Max Charging Current	2A Max
Standby Current	less than 100mA
Status LED	Green: charged Red: charging
Communication	
Interface	USB Mini-B Male connector supports data transmission of up to 12 Mbps OR Standard DB9 serial connector supports data transmission up to 115 Kbps Ethernet 10/100BASE-T(support only PM260-SE)
Agency Approvals	
Power Supply	UL listed TUV licensed Power Supply compliant to FCC part 15, Class B
Charging	CE Marking (EMC) CISPR Pub 22
Fire Retardant	UL 94- HB